

METALMASTER

OPERATION MANUAL



HYDRAULIC PRESS BRAKE E21 CONTROLLER

Model

PB-70E(2500) PB-70E (3200)

Order Code S900, Order Code S901

Edition No : PB-70E-4

Date of Issue : 11/2023

www.machineryhouse.com.au

MACHINE DETAILS**MACHINE**

HYDRAULIC PRESS BRAKE

MODEL NO.

PB-70E

SERIAL NO.**DATE OF MANF.**

Distributed by

www.machineryhouse.com.auwww.machineryhouse.co.nz**Note:**

This manual is only for your reference. Owing to the continuous improvement of the **Metalmaster** machine, changes may be made at any time without obligation or notice. Please ensure the local voltage is the same as listed on the specification plate before operating any electric machine.

**NOTE:**

In order to see the type and model of the machine, please see the specification plate. Usually found on the back of the machine. See example (Fig.1)

An example of a product specification plate. It features the Metalmaster logo at the top, followed by the title "PRODUCT SPECIFICATION". Below this are several rows of labels and input fields: "MODEL:", "CAPACITY:", "SER. NO:", "MFG DATE:", "WEIGHT:", "VOLTS:", and "MOTOR Kw:". At the bottom, it includes the website "www.machineryhouse.com.au" and "Made in China".

METALMASTER	
PRODUCT SPECIFICATION	
MODEL:	<input type="text"/>
CAPACITY:	<input type="text"/>
SER. NO:	<input type="text"/>
MFG DATE:	<input type="text"/>
WEIGHT:	<input type="text"/>
VOLTS:	<input type="text"/>
MOTOR Kw:	<input type="text"/>
www.machineryhouse.com.au	
Made in China	

Fig.1

CONTENTS:

1. GENERAL MACHINE INFORMATION	
1.1 Specifications.....	5
1.2 Standard Equipment.....	5
1.3 Identification.....	6
2. IMPORTANT INFORMATION	
2.1 General Metalworking Machine Safety.....	7
2.2 Specific Safety for Press Brake Machines.....	10
2.3 Lifting Instructions.....	12
3. INSTALLATION	
3.1 Site Selection and Preparation.....	13
3.2 Machine Leveling.....	14
3.3 Electrical Installation.....	14
3.4 Full Load Current.....	15
3.5 Checking The Power Supply.....	15
3.6 Attaching The Accessories.....	16
4. COMMISSIONING	
4.1 Press Brake Guarding - Light Curtain.....	17
4.2 Press Brake Guarding - Laser Guarding	19
4.3 Laser Setup & Calibration - Pre Nov 2023.....	20
4.4 Stopping test - Pre Nov 2023	21
4.5 Laser Setup & Calibration - Post Nov 2023	22
4.6 Stopping test - Post Nov 2023.....	23
4.7 Laser Safety Periodical check	25
4.8 Controls.....	26
5. OPERATION	
5.1 Starting The Machine For The First Time.....	27
5.2 Testing The Emergency Stops.....	28
5.3 Setting The Height Stops.....	28
5.4 Estun E21 Controller Operation.....	29
5.5 PB-70E E21 Press Brake Calibration: X Axis.....	31
PB-70E E21 Press Brake Calibration: Y Axis.....	32
5.6 Removing & Replacing Tools.....	33
5.7 Aligning The Punch And Die.....	34
5.8 Adjusting The Backgauge.....	34
5.9 Bending Techniques.....	35
5.10 Adjusting The Tonnage.....	37

6. MAINTENANCE	
6.1 Maintaining Hydraulic System.....	38
6.2 Lubrication.....	42
6.3 Troubleshooting.....	43
6.4 Top Tool Holder Wedge Adjustment.....	44
6.5 One Piece 4 Sided Die.....	45
6.6 Segmented Top Punch.....	46
Electrical Diagrams.....	47
Risk Assessment Sheets.....	52

1.1 SPECIFICATIONS

Order Code	S900	S901
Model	PB-70E	PB-70E
Control Unit (Type)	Estun NC-E21	Estun NC-E21
Safety Guarding System	~	~
Nominal Pressure - Tonnage (Ton)	70	70
Nominal Pressure - Kilo-newtons (kN)	630	630
Machine Axis (No)	2	2
Length of Work Table (mm)	2500	3200
Distance Between Columns (mm)	2050	2600
Maximum Open Height (mm)	325	355
Backgauge Travel (mm)	520	520
Throat Depth (mm)	260	260
Ram Stroke (mm)	90	90
Motor Power (kW / hp)	7.5 / 10	7.5 / 10
Motor Voltage (v)	415	415
Dimensions (L x W x H) (cm)	310 x 190 x 250	390 x 200 x 258
Shipping Dimensions (L x W x H) (cm)	280 x 160 x 220	340 x 170 x 225
Nett Weight (kg)	4400	5000

1.2 STANDARD EQUIPMENT

Front Sheet Supports
Mobile Foot Pedal Control
Instruction Manual

1.3 IDENTIFICATION

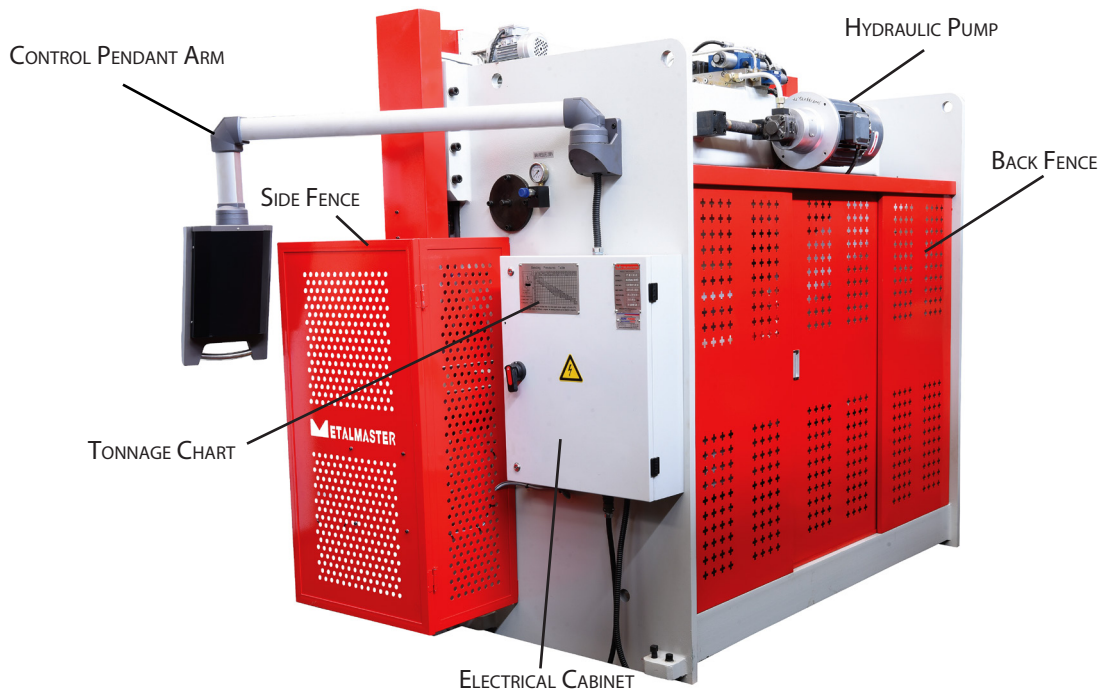

2.1 GENERAL METALWORKING MACHINE SAFETY

DO NOT use this machine unless you have read this manual or have been instructed in the use of this machine in its safe use and operation



WARNING

This manual provides safety instructions on the proper setup, operation, maintenance, and service of this machine. Save this manual, refer to it often, and use it to instruct other operators. Failure to read, understand and follow the instructions in this manual may result in fire or serious personal injury—including amputation, electrocution, or death.

The owner of this machine is solely responsible for its safe use. This responsibility includes, but is not limited to proper installation in a safe environment, personnel training and authorization to use, proper inspection and maintenance, manual availability and comprehension, of the application of the safety devices, integrity, and the use of personal protective equipment.

The manufacturer will not be held liable for injury or property damage from negligence, improper training, machine modifications or misuse.



- ✓ Always wear safety glasses or goggles.
- ✓ Wear appropriate safety footwear.
- ✓ Wear respiratory protection where required.
- ✓ Gloves should never be worn while operating the machine, and only worn when handling the workpiece.
- ✓ Wear hearing protection in areas > 85 dBA. If you have trouble hearing someone speak from one metre (three feet) away, the noise level from the machine may be hazardous.
- ✓ DISCONNECTION THE MACHINE FROM POWER when making adjustments or servicing.
- ✓ Check and adjust all safety devices before each job.
- ✓ Ensure that guards are in position and in good working condition before operating.
- ✓ Ensure that all stationary equipment is anchored securely to the floor.
- ✓ Ensure all machines have a start/stop button within easy reach of the operator.
- ✓ Each machine should have only one operator at a time. However, everyone should know how to stop the machine in an emergency.

2.1 GENERAL METALWORKING MACHINE SAFETY Cont.

- ✓ Ensure that keys and adjusting wrenches have been removed from the machine before turning on the power. Appropriate storage for tooling should be provided.
- ✓ Ensure that all cutting tools and blades are clean and sharp. They should be able to cut freely without being forced.
- ✓ Stop the machine before measuring, cleaning or making any adjustments.
- ✓ Wait until the machine has stopped running to clear cuttings with a vacuum, brush or rake.
- ✓ Keep hands away from the cutting head and all moving parts.
- ✓ Avoid awkward operations and hand positions. A sudden slip could cause the hand to move into the cutting tool or blade.
- ✓ Return all portable tooling to their proper storage place after use.
- ✓ Clean all tools after use.
- ✓ Keep work area clean. Floors should be level and have a non-slip surface.
- ✓ Use good lighting so that the work piece, cutting blades, and machine controls can be seen clearly. Position any shade lighting sources so that they do not cause any glare or reflections.
- ✓ Ensure there is enough room around the machine to do the job safely.
- ✓ Obtain first aid immediately for all injuries.
- ✓ Understand that the health and fire hazards can vary from material to material. Make sure all appropriate precautions are taken.
- ✓ Clean machines and the surrounding area when the operation is finished.
- ✓ Use proper lock out procedures when servicing or cleaning the machines or power tools.

DO NOT

- × Do not distract an operator. Horseplay can lead to injuries and should be strictly prohibited.
- × Do not wear loose clothing, gloves, necktie's, rings, bracelets or other jewellery that can be come entangled in moving parts. Confine long hair.
- × Do not handle cuttings by hand because they are very sharp. Do not free a stalled cutter without turning the power off first. Do not clean hands with cutting fluids.
- × Do not use rags or wear gloves near moving parts of machines.
- × Do not use compressed air to blow debris from machines or to clean dirt from clothes.
- × Do not force the machine. It will do the job safer and better at the rate for which it was designed.



BEFORE OPERATING ANY MACHINE, TAKE TIME TO READ AND UNDERSTAND ALL SAFETY SIGNS AND SYMBOLS. IF NOT UNDERSTOOD SEEK EXPLANATION FROM YOUR SUPERVISOR.

2.1 GENERAL METALWORKING MACHINE SAFETY Cont.

HAZARDS ASSOCIATED WITH MACHINES include, but are not limited to:

- Being struck by ejected parts of the machinery
- Being struck by material ejected from the machinery
- Contact or entanglement with the machinery
- Contact or entanglement with any material in motion

Health Hazards (other than physical injury caused by moving parts)

- Chemicals hazards that can irritate, burn, or pass through the skin
- Airborne items that can be inhaled, such as oil mist, metal fumes, solvents, and dust
- Heat, noise, and vibration
- Ionizing or non-ionizing radiation (X-ray, lasers, etc.)
- Biological contamination and waste
- Soft tissue injuries (for example, to the hands, arms, shoulders, back, or neck) resulting from repetitive motion, awkward posture, extended lifting, and pressure grip)

Other Hazards

- Slips and falls from and around machinery during maintenance
- Unstable equipment that is not secured against falling over
- Safe access to/from machines (access, egress)
- Fire or explosion
- Pressure injection injuries from the release of fluids and gases under high pressure
- Electrical Hazards, such as electrocution from faulty or ungrounded electrical components
- Environment in which the machine is used (in a machine shop, or in a work site)

WARNING

Machines are safeguarded to protect the operator from injury or death with the placement of guards. Machines must not be operated with the guards removed or damaged.

2.2 HYDRAULIC PRESS BRAKE SAFETY PROCEDURE

DO NOT use this machine unless you have been instructed in its safe use and operation and have read and understood this manual



Safety glasses must be worn at all times in work areas.



Long and loose hair must be contained or restrained



Appropriate protective footwear with substantial uppers must be worn



Coveralls, protective clothing, or a workshop apron, is recommended



Rings and jewellery must not be worn.



DO NOT wear large leather gloves when operating this machinery

PRE-OPERATIONAL SAFETY CHECKS

1. Ensure that all guards and safety devices are in position and secured.
2. Adjust all guards to minimum practicable clearances for the material to be pressed.
3. Note: any guards and safety devices should NEVER be removed, except for maintenance purposes, and only by an authorized staff member.
4. Working parts should be well lubricated and all jaws, fingers, 'V' blocks and blades be free of rust and other foreign matter.
5. Adjust the head rams to suit the material thickness.
6. Adjust and check that the 'v' forming blocks and/or knife blades are aligned correctly.
7. Be aware of any other personnel in the immediate vicinity and ensure the area is clear before using this equipment.
8. Familiarize yourself with all electrical, hydraulic and mechanical operations and controls, including the roving foot pedal control.

OPERATIONAL SAFETY CHECKS

1. Strictly only one operator is to use this heavy duty press brake, and, when necessary, with a safety observer present.
2. Never use any press or pan brake to bend or fold beyond the capacity of the machine.
3. Ensure that both hands are positioned away from any possible pinch point
4. Particular preparation and caution is to be observed when bending rod, strap or spring steel.
5. This heavy duty press brake is likely to be fitted with infra-red safety beams or electronic sensors to detect hazardous circumstances. If so, this machine should NOT operate if these safety devices are breached in any way, either by materials or by the operator.
6. Never leave the machine in operational mode while unattended.

POTENTIAL HAZARDS

- Entanglement and entrapment
- Striking and shearing
- Pinch, crush and squash
- Manual handling
- Electrical and hydraulic components
- Eye injury

SAFETY SYMBOLS

Fixed to the front of the press brake are safety symbols designed to make sure the machine is safely operated



Hearing and eye protection are extremely important as the result of an injury to these parts of the body may cause permanent damage. Safety glasses and hearing protection must be approved



When operating the press-bake hands and arms must at all times be kept from between the top and bottom die. Failure to do so may cause severe crushing.



With all hydraulic press brakes it is important that pressing takes place between the two rams in the center of the beam. This ensures equal pressure is applied to both rams.



Never attempt to support the end of the workpiece by holding it on either side of the tools. No part of your body must enter the hazardous area during bending operations. Beware of sudden movements of the worksheet during bending



Never hold the sheet by its folded edge; hold it from the sides

2.3 LIFTING INSTRUCTIONS

On the day that the machine arrives, make sure that a crane with sufficient capacity is available to unload the machine from the vehicle. Ensure access to the chosen site is clear and that doors and ceilings are sufficiently high and wide enough to receive the machine.

To handle the machine, the slings should be positioned so the machine is level when lifted. When using slings please take note of the sling angle and the loads that apply

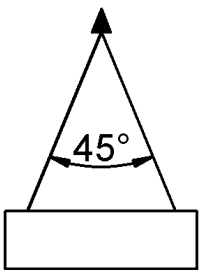

Fig 2.1.

When the slings are at a 45° angle then each sling is carrying the equivalent of 50% of load weight. (Fig.2.1).

When the slings are at a 90° angle then each sling will have a weight equal to 75% of the load on each sling. (Fig 2.2)

Note! The manufacturer recommends not to exceed 90° angle

Fig 2.2

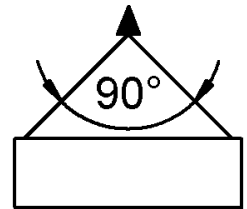

LIFTING POINTS

When lifting the machine only certified lifting slings should be used.

Ensure that when lifting, the machine does not tip over.

Check that the lifting slings do not interfere with the hydraulic pipes or electrical conduits.

Failure to follow these instructions could cause damage to the machine

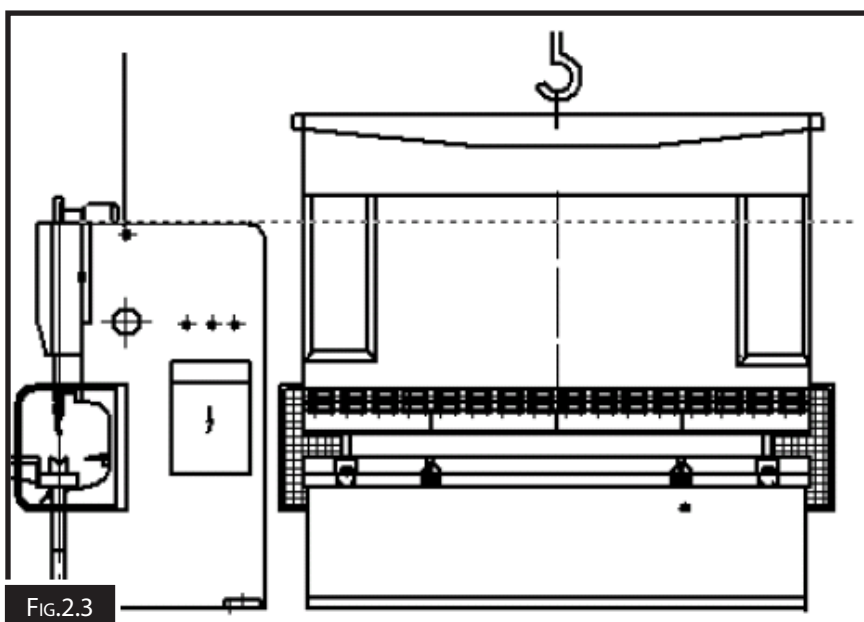

3. INSTALLATION

3.1 SITE SELECTION AND PREPARATION

The METALMASTER Press Brake must be installed on a rigid and stable floor such as a concrete slab 150 - 200mm thick. The press brake will be more stable if it sits on one slab and does not straddle slabs. Due to the design of the Press Brake with a high center of gravity bolting down to the floor is preferable.

The site must allow for access to the machine from all sides leaving enough room to cover any maintenance programs that need to be done.

The rear and front of the machine must allow for clearance of the work parts.

If no solid foundation can be found prepare the following foundation. (Fig.3.1)

Install the machine on the prepared foundation, and then fix using the foundation bolts. Once attached to the bolts do the final second grouting. After the cement has been solidified, check and correct the level of the machine. Check the bolt hole dimensions on the machine.

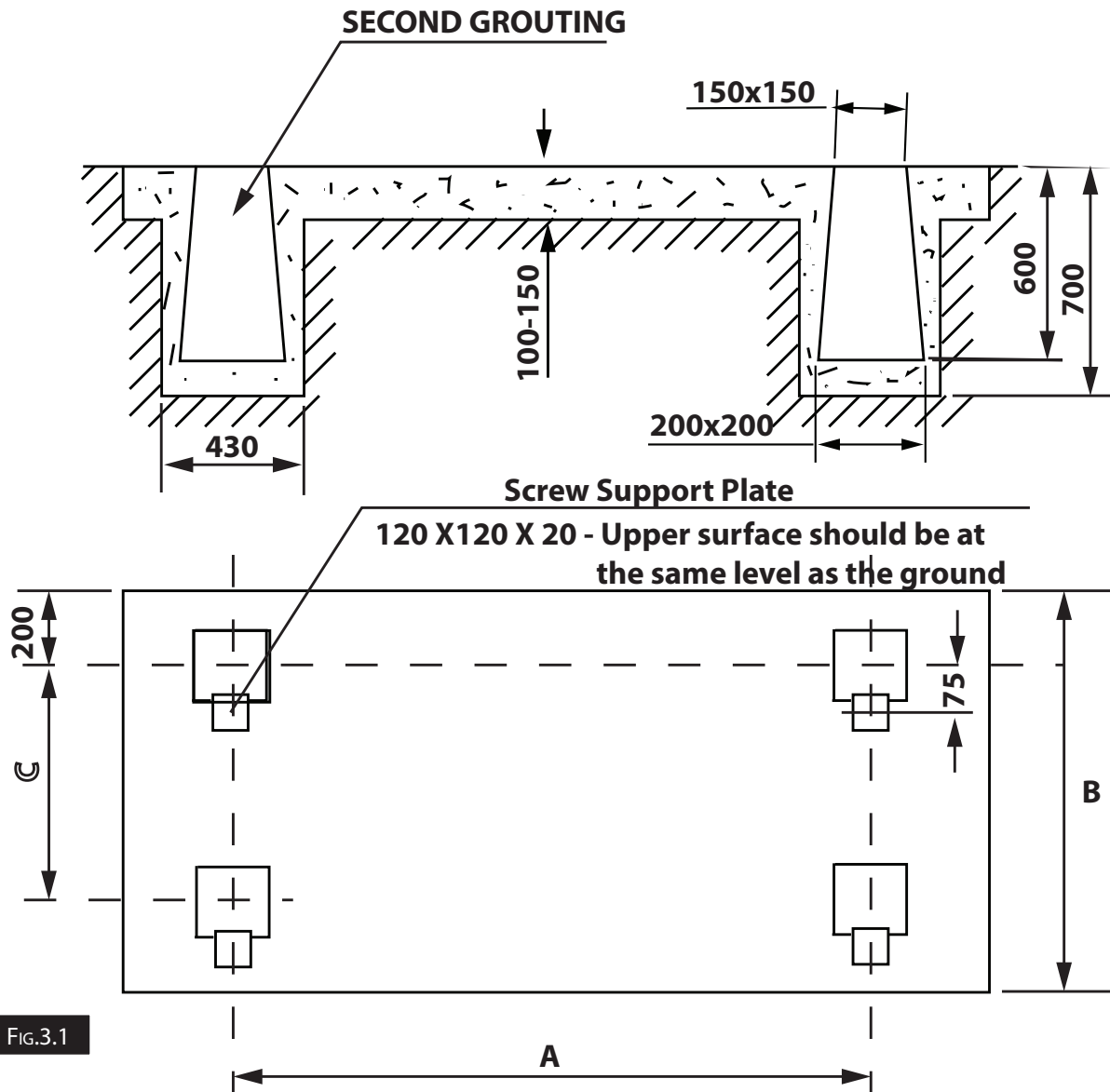

FIG.3.1

3.2 MACHINE LEVELING

To set your machine up so that it operates to optimum performance, apply the following leveling procedure

After your guillotine has been anchored to a concrete slab floor, it then needs to be leveled. The leveling is performed using the screws on each pad.(Fig. 3.2). Loosen the hold down bolts and place a level on the surface of the working table. Tolerances: 1000:0.30mm, for both longitudinal and transverse.

Metal plates need to be placed under each jacking screw to distribute the load. Once level then tighten the hold down bolts.

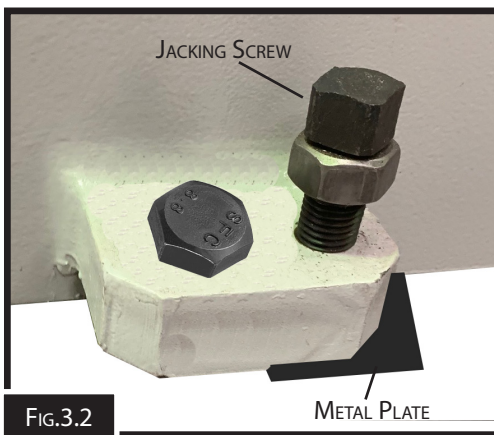

The machine must not rest on supports other than those defined in Fig. 3.2

3.3 ELECTRICAL INSTALLATION

Place the machine near an existing power source. Make sure all power cords are protected from traffic, material handling, moisture, chemicals, or other hazards. Make sure there is access to a means of disconnecting the power source. The electrical circuit must meet the requirements for 415V. To minimize the risk of electrocution, fire, or equipment damage, these machines should be hard wired with installation work and electrical wiring done by a qualified electrician.

NOTE : The use of an extension cord is not recommended as it may decrease the life of electrical components on your machine.

ELECTRICAL REQUIREMENTS

Nominal Voltage.....	415V
Cycle.....	50 Hz
Phase.....	Three Phase
Power Supply Circuit.....	25 Amps
FFull Load Current (S900).....	15.7 Amps
Full Load Current (S901).....	16.5 Amps

(Full load current rating is also on the specification plate on the motor.)

3.4 FULL-LOAD CURRENT RATING

The full-load current rating is the amperage a machine draws when running at 100% of the output power. Where machines have more than one motor, the full load current is the amperage drawn by the largest motor or a total of all the motors and electrical devices that might operate at one time during normal operations.

Full-Load Current Rating for these machine at 415V for (S900) is 15.7 Amps, (S901) 16.5 Amps. It should be noted that the full-load current is not the maximum amount of amps that the machine will draw. If the machine is overloaded, it will draw additional amps beyond the full-load rating and if the machine is overloaded for a long period of time, damage, overheating, or fire may be caused to the motor and circuitry.

This is especially true if connected to an undersized circuit or a long extension lead. To reduce the risk of these hazards, avoid overloading the machine during operation and make sure it is connected to a power supply circuit that meets the requirements.



3.5 CHECKING THE POWER SUPPLY

METALMASTER machines are supplied wired ready to run. Check the specification plate on the machine to confirm the local voltage is the correct voltage for the machine.

The machine must be connected to the power by a qualified and licensed electrician.

The motor direction must be checked as indicated below, to make sure the motor runs in the correct direction.

NOTE: *Warranty may be voided if it is found that the connection was not carried out by a qualified electrician.*

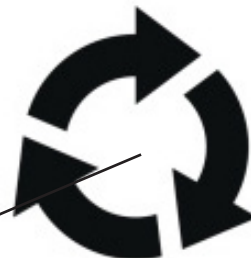

3.6 ATTACHING THE ACCESSORIES.

- ❑ Bolt the support arms onto the feed table. Ensure they are level and square to the table. (Fig.3.3)



- ❑ Unpack and attach both the side guards to the machine making sure they are square with the machine. (Fig3.4)



- ❑ Unpack the mobile foot control (Fig.3.5)

- ❑ Plug the mobile foot control into the socket provided on the machine under the electrical cabinet. (Fig.3.6)



4. COMMISSIONING

4.1 PRESS BRAKE GUARDING SYSTEM-LIGHT CURTAIN

Australian Legislation - Objects traveling at more than 10mm/second need physical or electronic guarding. Metalmaster use a combination of both on their press brakes.

Guarding System - This press brake has an electronic guarding system called Foldsafe. The system comprises of a Foldsafe box with a display, a PLC and circuit board. There is also a beam encoder, one set of light curtains (Fig.4.1), E-stops, back door switch etc. The PLC controls the safety depending on what signals it gets from all these components

Light Curtains - There is an emitter and a receiver in a light curtain set. (Fig.4.1) These are basically an electronic switch that can send a signal to the PLC in the guarding system indicating there is something in the work area.

Emitter - The LED on the emitter will not change and will always have a green light. (Fig.4.2)

Receiver - Has a green light (Fig.4.3) to indicate there is no obstruction between the light curtains or a red light (Fig.4.4) to indicate there is now an obstruction between the light curtains.

Note: *Light curtains must never be disabled.
Machines must not be used if the light curtain is faulty.*

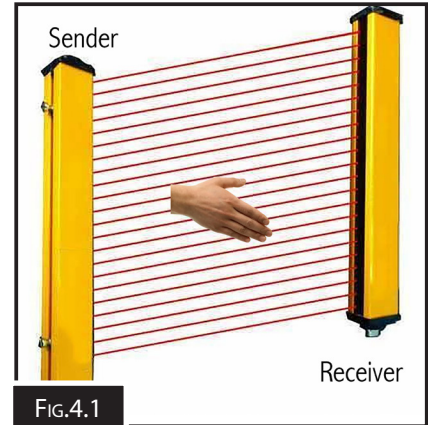

FIG.4.1



FIG.4.2



FIG.4.3



FIG.4.4

The light curtains serve two functions

- If the beam is traveling down fast and an obstruction is introduced, the light curtain sends a signal to the guard so it will stop the beam travel.
- If the light curtains are obstructed before the beam is moving, they send a signal to the guard so it will restrict the beam travel to slow speed.

Muting- This means the guarding system is bypassed, In this mode the safety system is forced into slow speed mode. There is a red warning light on the PLC box (Fig.4.7) to warn the operator that the guarding system has now been muted.

Muting can be achieved two ways.

- **Mechanical micro switch-** When the beam travels down fast speed and hits the mute switch the beam will be forced into slow speed.

The mute micro switch should be set 14mm above the work piece. (Fig.4.8)

- **Electronically -** If an obstruction is introduced between the light curtains or laser the press brake beam will be forced into slow speed.

BLANKING (Light curtain only)

Blanking is used so fast speed can still be achieved when the sheet supports have been mounted to the front of the machine. The blanking feature disables some of the light curtain beams so the sheet supports are not seen as an obstruction. (Fig.4.9)

Blanking is established by pressing the blank button on the Foldsafe screen and waiting for the guard to reload. Blanking will have a black dot next to it on the Foldsafe display.(Fig.4.11) Once the guard has been reloaded, the receiver will have a green light and the beam can travel down in fast speed.



FIG.4.7

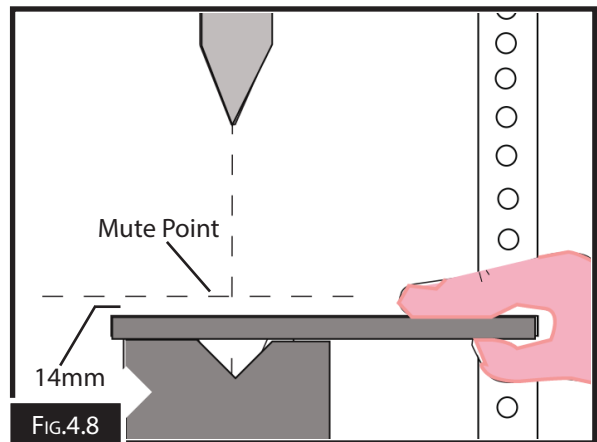

FIG.4.8

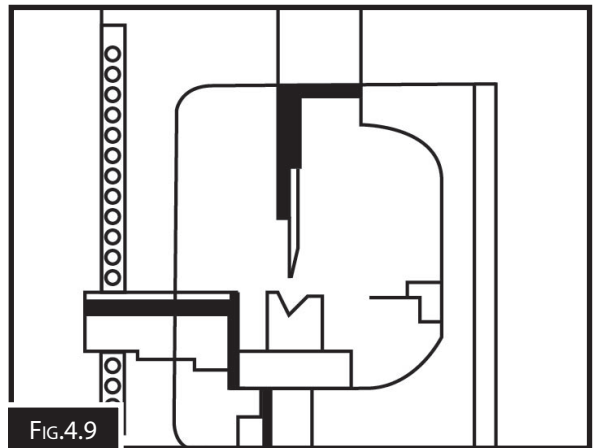

FIG.4.9

BLANKING OFF

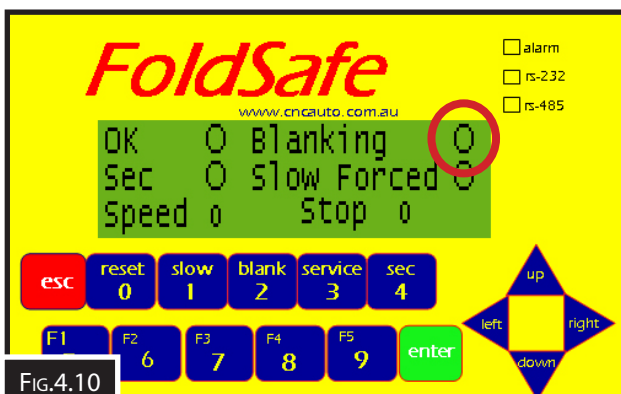

FIG.4.10

BLANKING ON

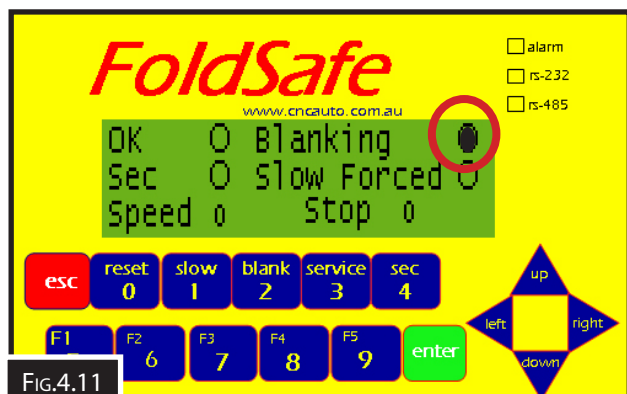

FIG.4.11

4.2 PRESS BRAKE GUARDING SYSTEM - LASER GUARDING

Australian Legislation - Objects traveling at more than 10mm/second need physical or electronic guarding. Metalmaster use a combination of both on their press brakes

Guarding System - This press brake has an electronic guarding system. The system comprises of a guarding box with a display, a PLC and circuit board. There is also a beam encoder, one set of Lasers (Fig.4.5), E-stops, back door switch etc. The PLC controls the safety depending on what signals it gets from all these components.

Laser Guarding - There is an emitter and a receiver in a Laser set. (Fig.4.5) These are an electronic safety device that can send a signal to the PLC in the guarding system indicating there is an obstruction in the working area.



FIG.4.5

Emitter - The LINK LED on the emitter will be green to advise the emitter is linked with the receiver (Fig.4.6)

Receiver- Has a green "ON" LED (Fig.4.5) to indicate all 3 protection zones of the laser are aligned and linked. Protection zone E1, E2 & E3 lights turn RED when there is an obstruction (Fig.4.6)

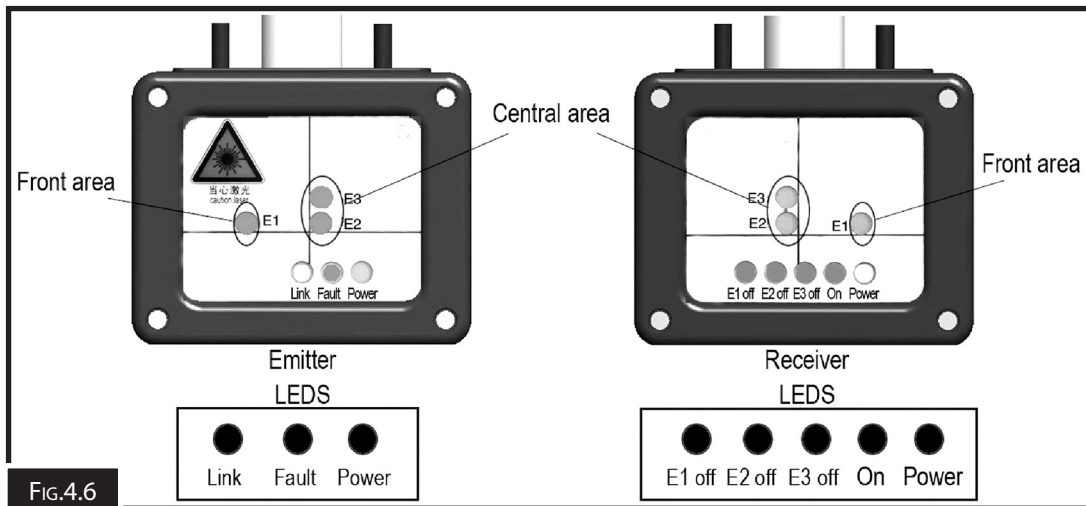

FIG.4.6

The laser system serves two functions

- If the beam is traveling down fast and an obstruction is introduced, the laser system sends a signal to the PLC so it will stop the beam travel.
- If any laser protection zone is obstructed before the beam is moving, they send a signal to the guard so it will restrict the beam travel to slow speed.

* *Lasers must never be disabled. Machines must not be used if the laser system is faulty.*

4.3 LASER GUARDING SETUP & CALIBRATION - (Pre Nov 2023)

Aiming aids -

- Used to align the lasers to the punch.
- Spring loaded to allow the punch to lightly press into V opening
- Place on both ends of the tooling for alignment.
- Predefined reaction time settings, The reaction time is the distance the beam travels after being told to stop.



Setup the Aiming aids -

- Loosen the locking screw and adjust both aiming aids to 9mm
- Tighten the locking screw ensuring the 9mm setting is maintained

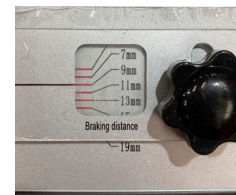

Align TX Emitter -

- Place an aiming aid on each end of the punch tooling to be setup.
- Gently inch the beam down until the punch touches the V in the aiming tool
- DO NOT Compress the springs completely.
- Align the Emitter so the E2 laser runs directly through the center of the E2 hole of both aiming aids

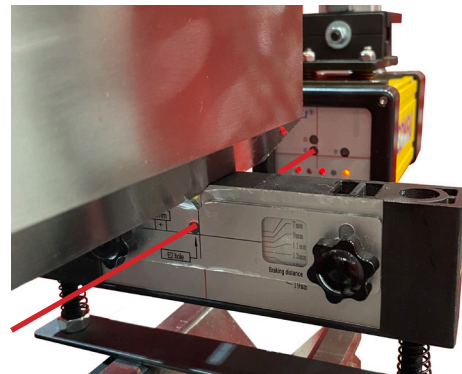
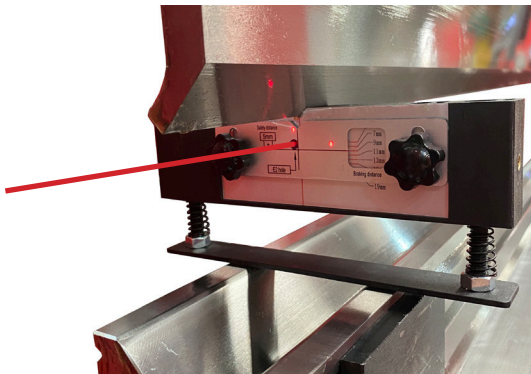

Align RX Receiver -

- Align the receiver mounting arm so all 3 lasers from the Emitter (E1, E2 & E3) are all aimed in the center of the corresponding E1, E2, E3 on the receiver.

The green "ON" LED will be illuminated at correct alignment.



4.4 LASER GUARD STOPPING TESTING - (Pre Nov 2023)

NEVER PLACE YOUR LIMBS IN BETWEEN THE PUNCH AND DIE

Inspection at start-up, shift change or after laser adjustment.

The laser optical lenses must be free of any dust, ingress, and damage.

When the detection area is unobstructed, the green "On" LED on the receiver must be ON.

Block the detection area, the green "On" LED on the receiver must turn OFF.

The beam must transition to slow speed with the punch at least 20mm from the die.

From the top of the beam stroke, bring the beam down in fast mode (+50mm/s) onto a 35-50mm thick obstruction. The beam must stop **at least 5mm** above the obstruction every time.

Repeat this obstruction test at multiple locations along the entire length of the pressbrake.

If this test is not successful, there may be something wrong with the laser set-up, please double check the setup as per section 4.3 of this manual.

If the test still fails please call for service.

The following schedule shall be followed for periodical testing:

- At pressbrake startup
- After each tool change
- After operator change
- After each scheduled operator break
- After each operator change of shift
- Whenever the TX Emitter or RX Receiver has been moved

4.5 LASER GUARDING SETUP & CALIBRATION - (Post Nov 2023)

Setup tool - Aiming aid - The user is responsible to correctly adjust the laser device when different length tools are used, setup and verification of these adjustments are confirmed by testing with the aiming aid.

Aiming aid -

- Used to align the lasers to the punch.
- Attached by magnet to the Top punch.
- Place on both ends of the tooling for alignment.
- 3 predefined reaction time settings, The reaction time is the distance the beam travels after being told to stop.



Align TX Emitter -

- Place and aiming aid on each end of the punch tooling to be setup.
- Align the aiming aid through the see through 9mm V setting with the V of the punch tip
- Adjust the emitter mounting arm so the E2 laser runs directly through the center on the L2 hole of both aiming aids.

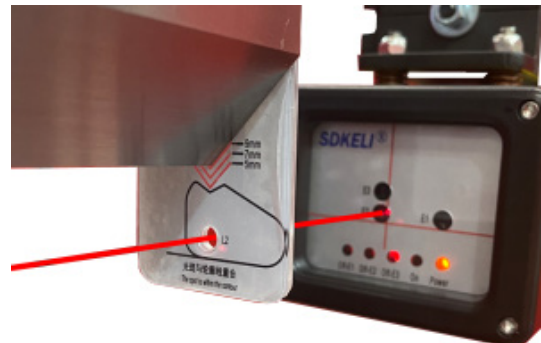
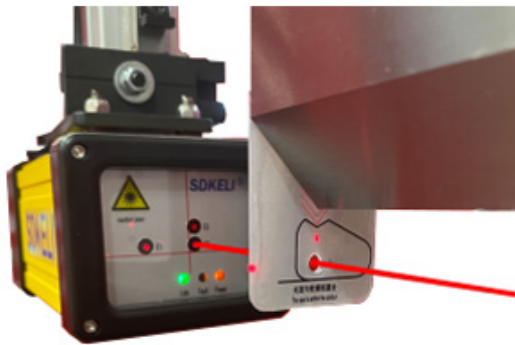

Align RX Receiver -

- Align the receiver mounting arm so all 3 lasers from the Emitter (E1, E2 & E3) are all aimed in the center of the corresponding E1, E2, E3 on the receiver.

The green "ON" LED will be illuminated at correct alignment.



4.6 LASER GUARDING STOPPING TEST - (Post Nov 2023)

Option 1 : Small V Method

Use this method if you are using a smaller V size where you can easily place the Aiming Aid on the end of the die block.

Setup :

- a) Before proceeding please ensure the Laser setup & calibration has been performed as per section 4.3 of this manual.
- b) Ensure during Fast Speed, the beam is travelling at least 50mm/s, the mute switch is not triggered, and any other obstruction is removed during the test.
- c) Place the Aiming Aid on the end of the die block. The end of the aiming aid should extend past the top of the die by at least 35mm as shown in the image.



Testing:

- a) Raise the beam to maximum opening height.
- b) With the footpedal bring the beam down (fast mode) It should suddenly stop once it detects the obstruction.
- c) Measure the clearance between the tip of the punch and the top of the aiming aid.

TAKE CARE NOT TO ACCIDENTLY MOVE THE AIMING AID WHEN MEASURING!

There must be at least be 5mm clearance.

- d) Repeat this process on the left side.

If this test is not successful, there may be something wrong with the laser set-up, please double check the setup as per section 4.3 of this manual. If the test still fails please call for service.

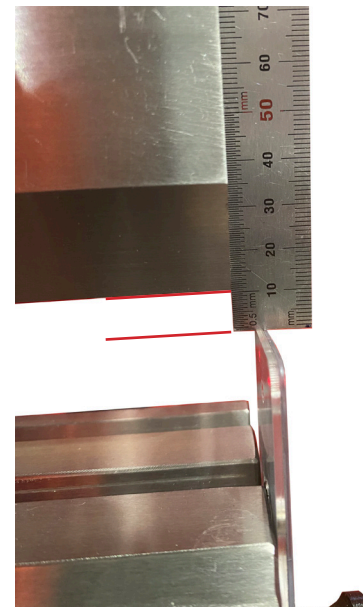

Option 2 : Large V Method

Use this method if you are using a large V size where you can not easily place the Aiming Aid on the end of the die block.

Setup :

- a) Before proceeding please ensure the Laser setup & calibration has been performed as per section 4.3 of this manual.
- b) Ensure during Fast Speed, the beam is travelling at least 50mm/s, the mute switch is not triggered, and any other obstruction is removed during the test.
- c) Place the Aiming Aid on the side of a 6mm+ piece of steel, The end of the aiming aid should extend past the top of the steel by at least 35mm as shown in the image.

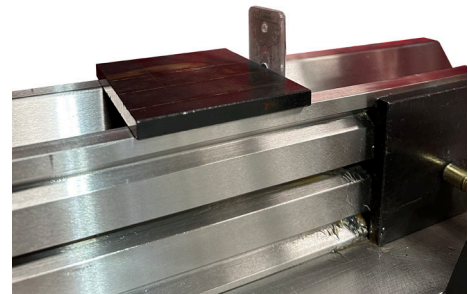
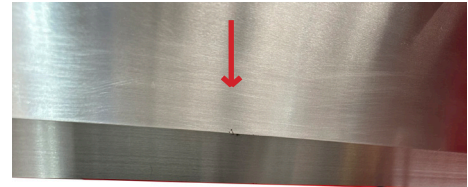
**Testing:**

- a) Raise the beam to maximum opening height.
- b) With the footpedal bring the beam down (fast mode) It should suddenly stop once it detects the obstruction.
- c) Measure the clearance between the tip of the punch and the top of the aiming aid.

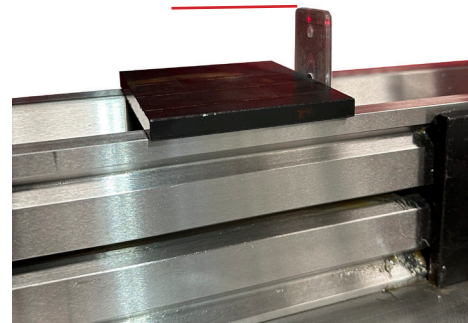

TAKE CARE NOT TO ACCIDENTLY MOVE THE AIMING AID WHEN MEASURING!

There must be at least be 5mm clearance.

- d) Repeat this process on the left side.

If this test is not successful, there may be something wrong with the laser set-up, please double check the setup as per section 4.3 of this manual. If the test still fails please call for service.

4.7 LASER SAFETY DEVICE PERIODICAL CHECK

The alignment & calibration of the laser system emitter & receiver along with the machines punch tooling shall be checked using the supplied calibration & testing aids.

Section 4.3 or 4.5 "Laser guarding setup and Calibration" shall be used for the setup depending on the aiming aids supplied with your machine.

Section 4.4 or 4.6 "Laser guarding stopping test" shall be used for the testing depending on the aiming aids supplied with your machine.

Refer Pages 19~24 of this manual.

The following schedule shall be followed for periodical testing:

- At pressbrake startup
- After each tool change
- After operator change
- After each scheduled operator break
- After each operator change of shift
- Whenever the TX Emitter or RX Receiver has been moved

4.8 CONTROLS

The purpose of this control overview is to provide the novice machine operator with a basic understanding of how the machine is used during operation, and the machine controls and what they do. It also helps the operator to understand if they are discussed later in this manual.

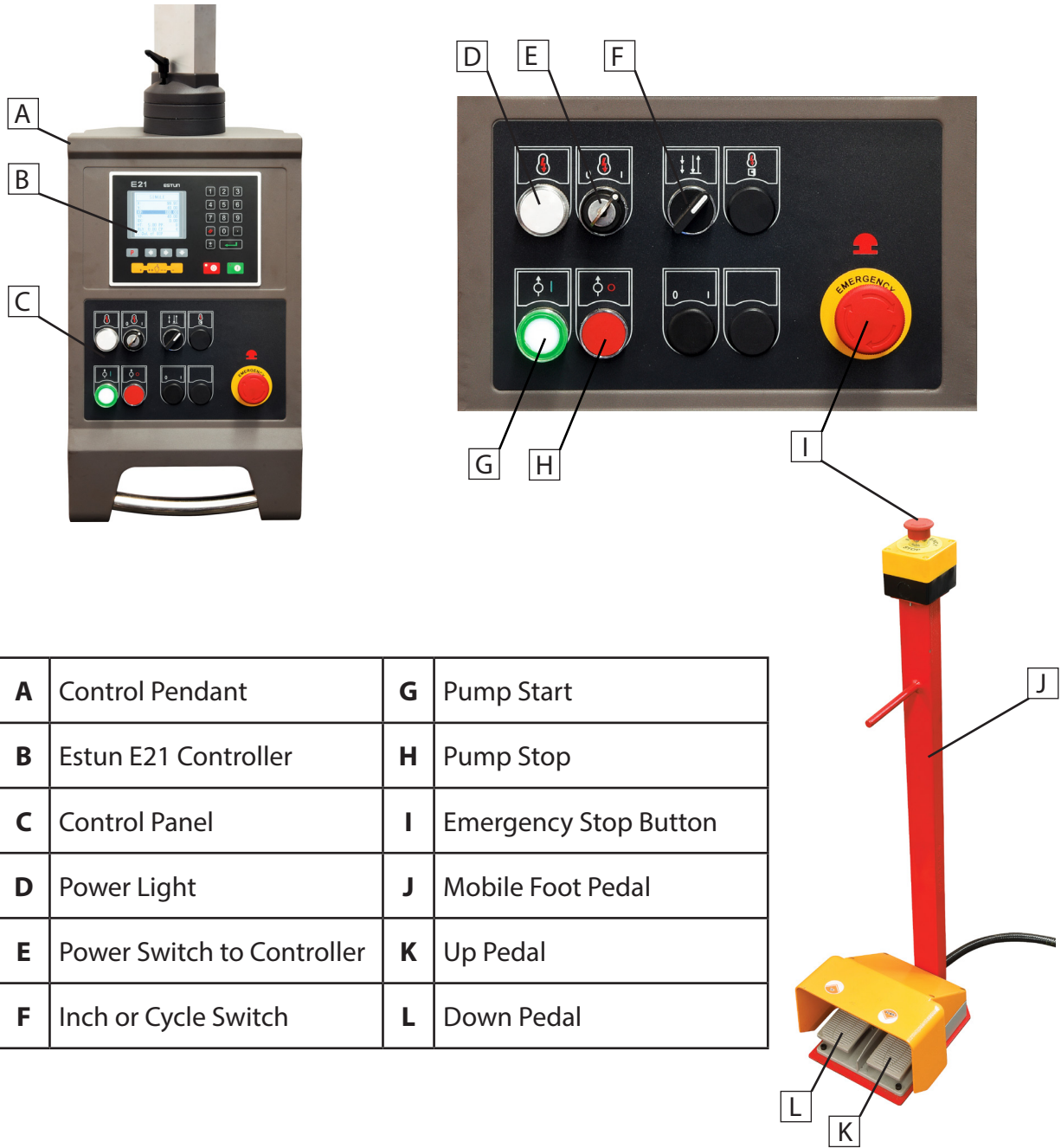

A	Control Pendant	G	Pump Start
B	Estun E21 Controller	H	Pump Stop
C	Control Panel	I	Emergency Stop Button
D	Power Light	J	Mobile Foot Pedal
E	Power Switch to Controller	K	Up Pedal
F	Inch or Cycle Switch	L	Down Pedal

5. OPERATION

The Model PB-70E will perform many types of operations that are beyond the scope of this manual. Many of these operations can be dangerous or deadly if performed incorrectly. The instructions in this section are written with the understanding that the operator has the necessary knowledge and skills to operate this machine. If you are experiencing difficulties performing any operation, stop using the machine! If you are an inexperienced operator, we strongly recommend that you read books, trade articles, or seek training from an experienced operator. **Above all, your safety should come first!**

5.1 STARTING THE MACHINE FOR THE FIRST TIME.

1. Turn the main isolation switch ON and wait for the controller and Foldsafe unit to load up.(Fig.5.1)
2. Press the RESET button on the Foldsafe unit. (Fig.5.2)
3. Press the pump start button. (Fig.5.3)
4. Press the green program start button on the controller
5. The Foldsafe guarding system must now do a pump test so it can measure how quickly the beam will stop during an emergency. The beam has to travel down for about 50mm so if the beam is down the bottom of the stroke use the foot pedal to raise the beam ready for the pump test. (Fig.5.4)
6. Press the foot pedal to make the beam travel down. The guard will cut out the pump after 50mm and measures how quickly the beam stops. The guard takes 3 seconds to calculate this so you must LEAVE your foot on the foot pedal until the screen changes. If it is within the safety limits of the guard the pump can be started again
7. If it is not within the limits there will be an error on the Foldsafe screen. It will display the error. You can try to perform the pump test again, if it fails again then the problem needs to be rectified. Contact your service provider
8. If OK then the Press Brake is now ready for operation.



FIG. 5.1



FIG. 5.2

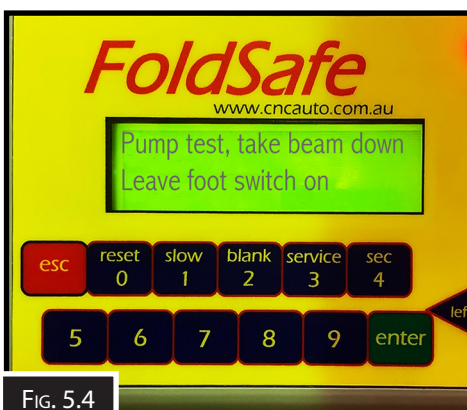

FIG. 5.4



FIG. 5.3

5.2 TESTING THE EMERGENCY STOPS.

The Metalmaster Press Brake model PB-70E is fitted with two emergency stop buttons. One is on the mobile foot pedal and the other is on the pendant control panel. They should be tested one at a time to ensure they are working correctly.

To test the emergency stops:

1. Make sure that all the emergency buttons have been reset
2. Start the machine and then press the emergency stop on the pendant. The machine's hydraulic pump should stop and the power should be cut off. (Fig.5.5)
3. Try to restart the hydraulic pump by pressing the green pump start button. If the pump will not start then the emergency stop is working correctly.
4. Reset the emergency button by twisting the top red section until the red section pops up.
5. Press the green pump start button again. The pump should now start. The emergency stop is working correctly.
6. Repeat steps 1-5 for each of the other emergency stop buttons. (Fig.5.6)

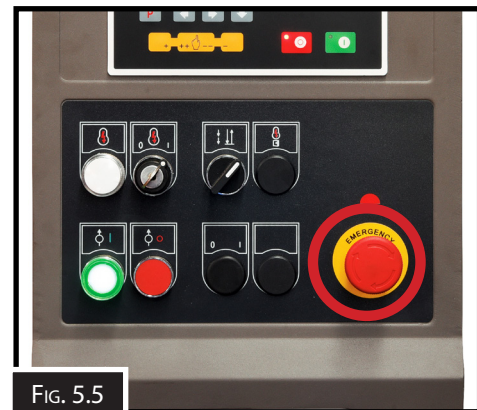

5.3 SETTING THE HEIGHT STOPS

The Model PB-70E is fitted with two stops. The top switch sets the return height and the lower switch is used to change the speed of the beam from the approach speed to the bending speed (low speed). Check the workpiece to make sure that the points allow easy access of the piece to be formed.

To set the heights:

1. Switch the controls to "INCH"
2. Inch the beam down until it is 14mm above the work piece, and set the bottom switch so that it is depressed. This will now be the mute point.
3. Return the top tool beam to the top position, then inch down the top tool beam until it reaches the desired return point and set the top switch. This will now be the point at which the top tool beam returns to. (Fig.5.7)



5.4 ESTUN E21 CONTROLLER OPERATION

SINGLE: Common page that is used by anyone who wants to re-write a job.

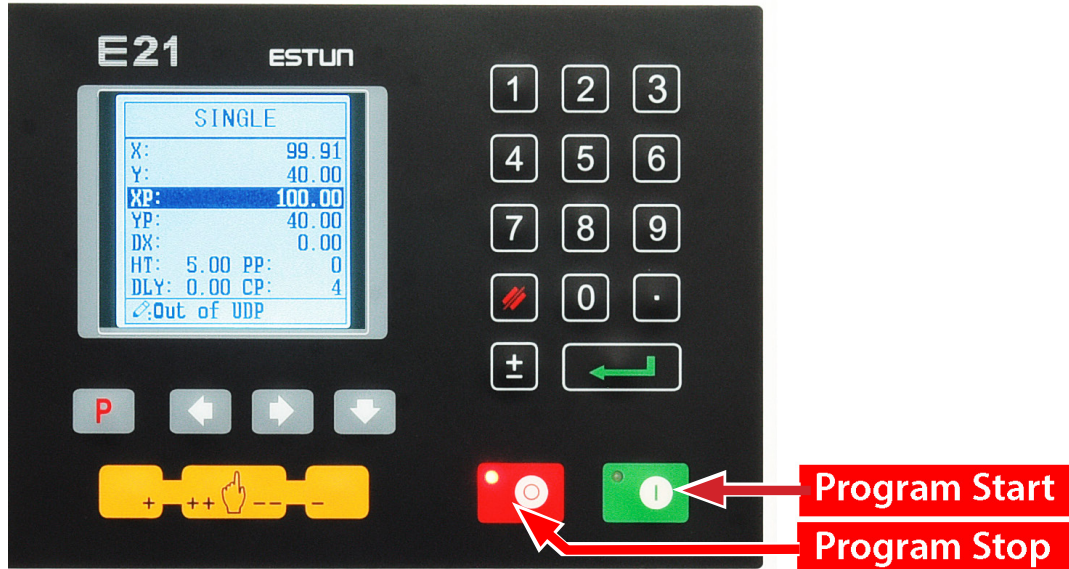

- X** - (X Back gauge actual position)
- Y** - (Y Ram stroke actual position)
- XP** - (X Program Position) - Back gauge distance from the blade
- YP** - (Y Program Position) - Ram stroke depth. (Test bends must be done)
- DX** - (Distance of Back Gauge Retraction) - Amount the back gauge will retract at mute point
- HT** - (Hold Time) - Dwell time at the bottom of the stroke
- PP** - (Program Pieces) - Number of jobs to be bent
- DLY** - (Delay Retraction) - Time delay in seconds for the back gauge to retract when beam reaches mute point
- CP** - (Completed Pieces) - Amount of jobs that have been completed

Operation: With XP highlighted, type 50.0 and press the enter button. The controller will save this parameter and then highlight YP ready for entry. Continue the same process until all parameters have been entered and then press green program start button. The controller will now find X & Y position. Once it has found position you can start to bend using foot pedal or hand operation.

Example: This job will bend a 50mm return with a Y depth of 38. There is a 50mm back gauge retraction with no delay. There are 20 pieces to bend and 0 pieces have been completed so far. There is a Hold Time of 2 seconds.

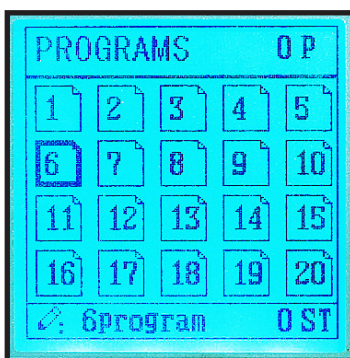

PROG: Program management page

This page gives access to all the saved programs, there are 40 programs and ability to save 25 steps for each program.

Operation: Press the **P** (program button) until Program management page has been located. Enter **6** and press enter, this will take you straight to the Product Information Page for program **No-6**.

5.4 E21 CONTROLLER OPERATION

PROG: Product Information Page

This page lets you enter parameters for the pieces to be bent.

- ST** - (Steps) There are 3 steps in this program
- PP** - (Programed Pieces) - 5 jobs to be bent
- CP** - (Completed Pieces) 0 pieces completed
- DLY** - (Delay Retraction) - 1 second time delay for the back gauge to retract
- HT** - (Hold Time) - 2 seconds dwell time will start when the top beam hits the mute switch
- Retract Delay** - 1 second delay for the back gauge to retract



Operation: With ST highlighted type 3 and press the enter key, this will save parameter and PP will then be highlighted. Continue until all desired parameters have been entered.

Example: This job has 5 pieces to be bent and each piece has 3 bends in it. There are 0 pieces bent yet, the back gauge has a 1 second delay when retracting and a hold time of 2 seconds.

NOTE: ENSURE THAT THERE IS ENOUGH DWELL TIME TO BUILD UP PRESSURE AT THE BOTTOM OF THE STROKE TO COMPLETE THE BEND.

PROG: Individual Cut Information Page

This page lets you enter information for each individual bend.

- X** - (X Back gauge actual position)
- Y** - (Y Ram stroke actual position)
- XP** - (X Program Position) - 200mm back gauge distance from the blade
- YP** - (Y Program Position) - 38 ram stroke depth. (Test bends must be done)
- DX** - (Distance of Back Gauge Retraction) - 50mm back gauge retraction
- RP** - (Repeat) - Set to 1 bend. (The amount of times this bend will be done before moving to bend 2)

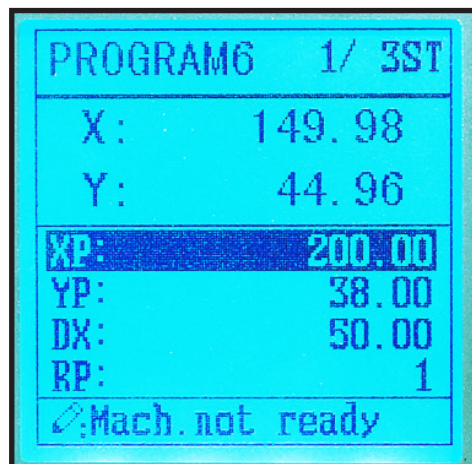

Operation: With X highlighted, type 200 and press the enter button. The controller will save this parameter and then highlight Y ready for entry. Continue the same process until all desired parameters have been entered. Once bend 1 is complete press , this will take you to bend 2 so parameters can be entered. Once all bends have parameters arrow back to bend 1 and press the green program start button. The controller will now find X & Y position. Once it has found position you can start bend jobs using foot pedal or hand operation.

Example: Program 6 has 3 bends and the screen is on bend 1. Bend 1 has a 200mm return and the ram stroke has a Y value of 38. The back gauge will retract 50mm and bend 1 will be bent once before the controller moves to bend 2.

5.5 PB-70E E21 PRESS BRAKE CALIBRATION: X AXIS

The Metalmaster Press Brake is calibrated before the machine leaves the factory and should not need to be calibrated. However should the machine at any time need to be calibrated, the following is the procedure.

1. Use a rule and manually move back gauge until it measures 100mm between back gauge finger and the middle of pressing V.



2. Press P until "CONST" page is located.
3. Type password (1212) and press enter to locate Teach screen.

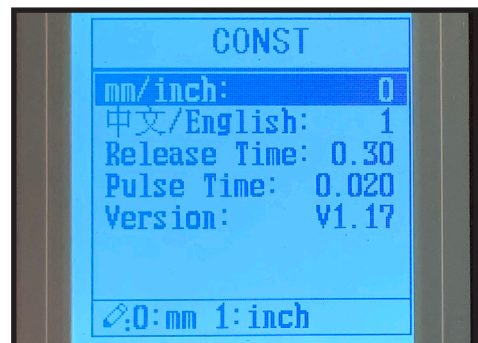

4. In the teach screen, highlight X, and type 100 and then press enter.

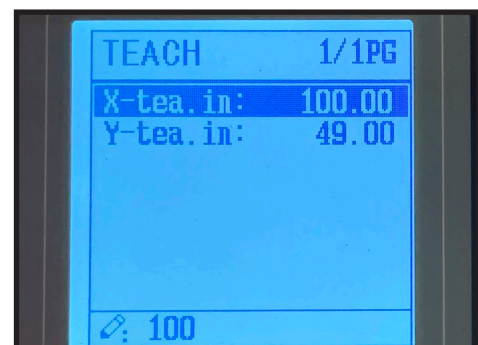

5. Press P twice to exit and return to the "Single" page..

6. Check X = 100mm on the "Single" page.

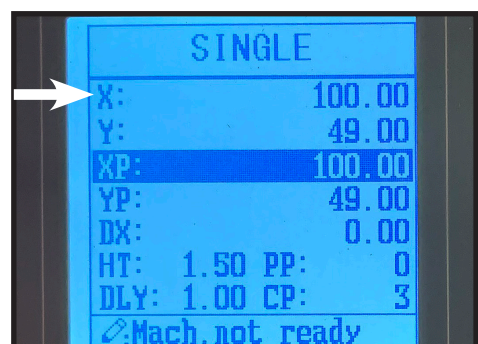

5.5 PB-70E E21 PRESS BRAKE CALIBRATION: Y AXIS

The model PB-135E Press Brake has no hard limit micro switches fitted to the machine. It relies simply on the soft limits.

The Soft limit is a Software limit that is set on the controller

1. Start the Press Brake and take the beam up to the maximum opening height.
2. In single screen use the "Minus" key which will take you to the "Manual Page
3. Highlight the "Y" axis and using the minus button move Y axis up until the soft limit stops the movement of the ram stroke screw.

NOTE: When using the "Plus" or "Minus" key, on the "Y" axis there is no rapid movement.

4. Press P twice to exit and take you to the Single Page and check that Y = 1.
5. Bring the beam down until it stop on the ram stroke screws
6. Check that the measurement between the top and bottom die is 20mm
7. If the gap is not 20mm use the plus or minus buttons to move the Y axis up or down until you can achieve a 20mm gap between the top and bottom die.
8. Press P until "CONST" page is located, type password (1212) and press enter to locate the Teach screen
9. In the Teach screen, highlight Y, and type 1 and then press enter.
10. Press P twice to exit and return to the "Single" page and check that Y = 1.

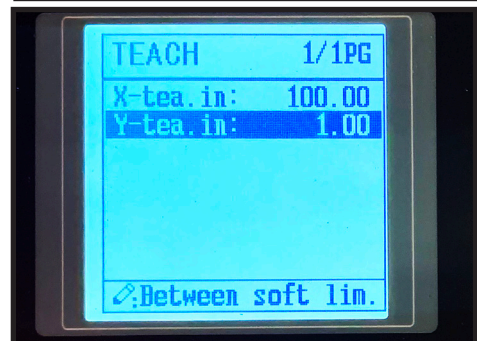
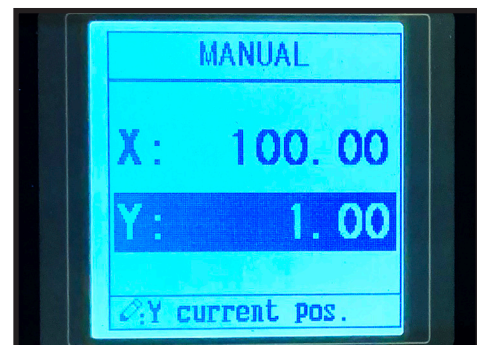
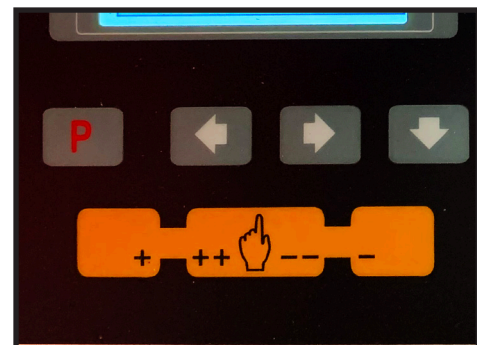
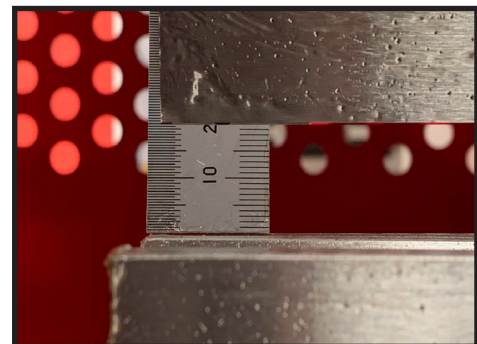
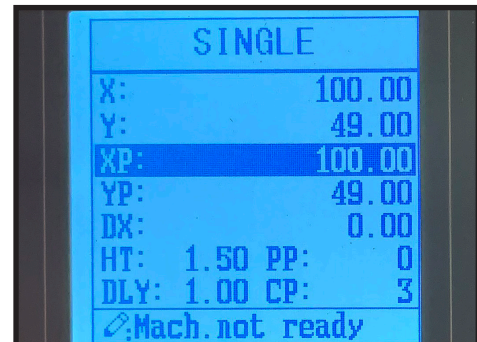

5.6 REMOVING & REPLACING TOOLS

Installing and Removing The Die:

To remove the die, loosen the clamp screws (Fig.5.8) and lift the die off the machine.

NOTE: Please use safe lifting practices when removing or replacing the die.

Install 2V-dies so that the V-groove to be used faces the rear of the machine by considering safety in the event of die breakage. Use the clamp screws to line-up the die with the punch.

When using two or more dies, install them with a clearance of about 5 mm between them.

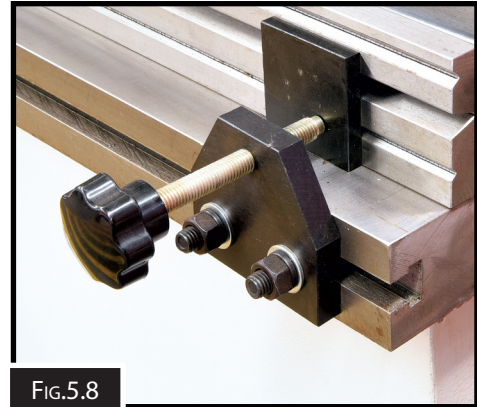

FIG.5.8

Removing Punches

When changing the tools, strictly observe the following cautions:

- Never put your hand or hands between the punches and dies, to support the punch
- Before removing the punches, switch the controls to the INCH mode and move the ram down to the desired position,
- Turn the POWER ON/OFF switch to OFF.
- When you remove the tools with an assistant operator or operators, be sure to coordinate your work with them.
- Be sure to remove the punches first and then the dies.

To remove the punch:

1. Loosen the fixing bolts of the punch clamping plate or plates. (Fig.5.9) The punch drops onto the V-groove of the die. (Fig.5.10)
2. Slide the punch sideways to remove it.

Installing Punches

Before installing the tools, wipe off the upper beam and punch installation surfaces and tools,

1. Slide the punch into the V-groove of the die as shown. (Fig.5.9)
2. Determine the installation position of the punch by sliding it left and right, and lightly tighten the fixing bolts of the punch clamping plate or plates.

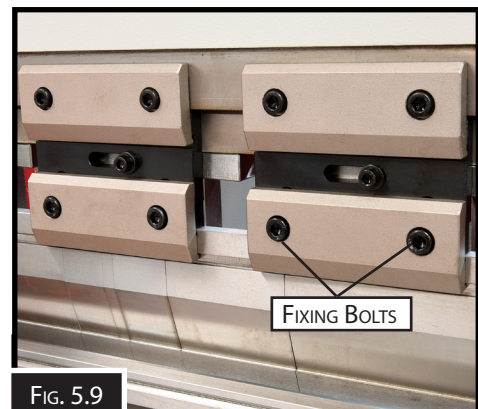

FIG. 5.9

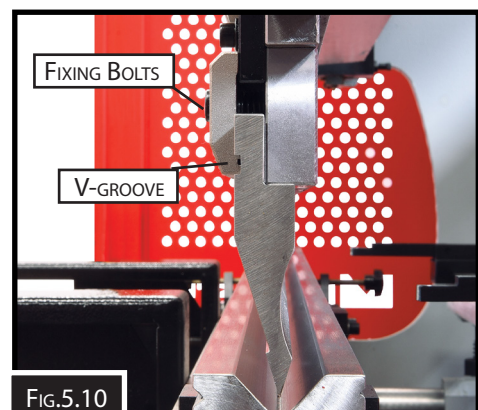

FIG.5.10

5.7 ALIGNING THE PUNCH AND DIE

When you reinstall the dies after removing them together with the die holders, align them again.

To Align the Tools:

1. Start the machine.
2. Set the mode to "INCH".
3. Loosen the die clamps. (Fig.5.11)
3. Inch the top tool beam down until the top punch is level with the top of the die. With a rule measure the distance from the point of the punch to each side of the V in the die block. Adjust the die clamps until they are equal and the punch is in the centre of the V in the die block, using the die clamps to move the die.
4. Tighten the die clamps evenly until the die is secure.



FIG.5.11

5.8 ADJUSTING THE BACKGAUGE

It is important that the backgauge height is parallel with the bottom die, and that the sheet fingers of the back gauge are higher than the bottom die and will not smash into the die.

To adjust the height of the backgauge:

1. Move the backgauge so the fingers are around 50mm from the die.
2. DISCONNECT THE MACHINE FROM THE POWER
3. Using a straightedge on the top of the bottom die, check that the fingers just clear the die block..
4. If the fingers need to be raised or lowered then release the lock nuts (Fig.5.12) and adjust the height of the fingers accordingly, making sure that both ends are adjusted so that the back gauge remains parallel.
5. Once the height of the fingers has been set and the fingers have been moved to the position required, then final adjustment if required can be made to make sure that both fingers are the same distance from the die. If required the fingers can be moved in or out by loosening the lock nuts and using the adjuster to move the fingers. Once in position re-lock the lock nut. (Fig.5.13)



FIG.5.12

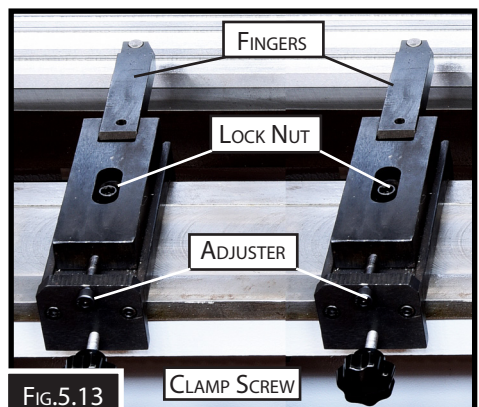

FIG.5.13

5.9 BENDING TECHNIQUES

There are two basic bending techniques:

- AIR BENDING

This method is commonly performed because relatively low bending forces are required

- COINING

This method requires forces approximately three to five times those of air bending. It allows the inside radius to be coined. This method almost eliminates the elasticity of the material.

AIR BENDING

During air bending, the sheet metal retains certain amount of elasticity. An acute angle, higher than the desired angle, is generally bent to compensate for the spring back effect. The controllers are designed to take into account all these parameters required for air bending. The bending chart (Fig.5.16) located on the side of the press brake shows the required force and internal radius which can be achieved along with the other characteristics such as the thickness of the material and the die opening,

During air bending, the sheet is in contact with the tools at three points (A, B, C) as shown in the diagram Fig.5.14

To obtain a quality bend using air bending, it is necessary that the die opening is between 6-12 times the sheet thickness. In this way, sheet angle is reached before it touches the bottom of the die. Consult the bending chart for

1. What size die to use,
2. What the minimum return size can be for the die being use
3. What radius will be achieved
4. What tonnage it will take to bend the material per metre.

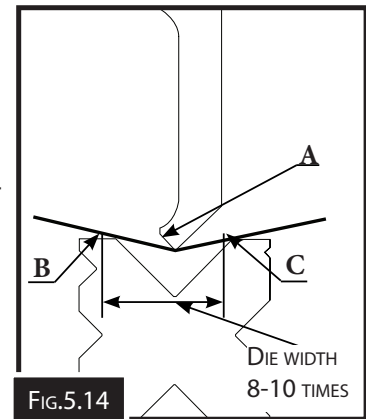

COINING

This type of bending is where the end of the punch presses the sheet to the bottom of the die, rupturing the elasticity of the sheet. This then causes the sheet to be bent exactly to the shape of the punch. (Fig.5.15)

Note! This requires special tooling to be purchased and standard tooling can not be used.

When buying this type of tooling please insure that they supply you with the correct bending chart to suit the tooling. The forces at the end of bending are 3 to 5 times the air bending forces, which causes the coining of the sheet.

NOTE: The choice of the top die radius is very important for coining, because it determines the inside radius of the bend in the sheet. Coining can only be performed with a punch and die of the same angular value.

Very high bending forces must be applied. These may reach values from 3 to 5 times those shown on the air bending chart.

CAUTION: Because coining involves very high forces, take great care to check the strength of the tools being used
 Never exceed the applicable force limits. Contact you tool supplier if unable to find the values.

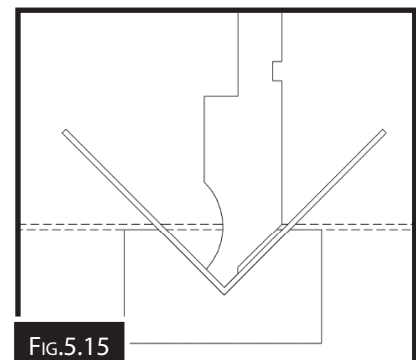

TONNAGE BENDING CHART

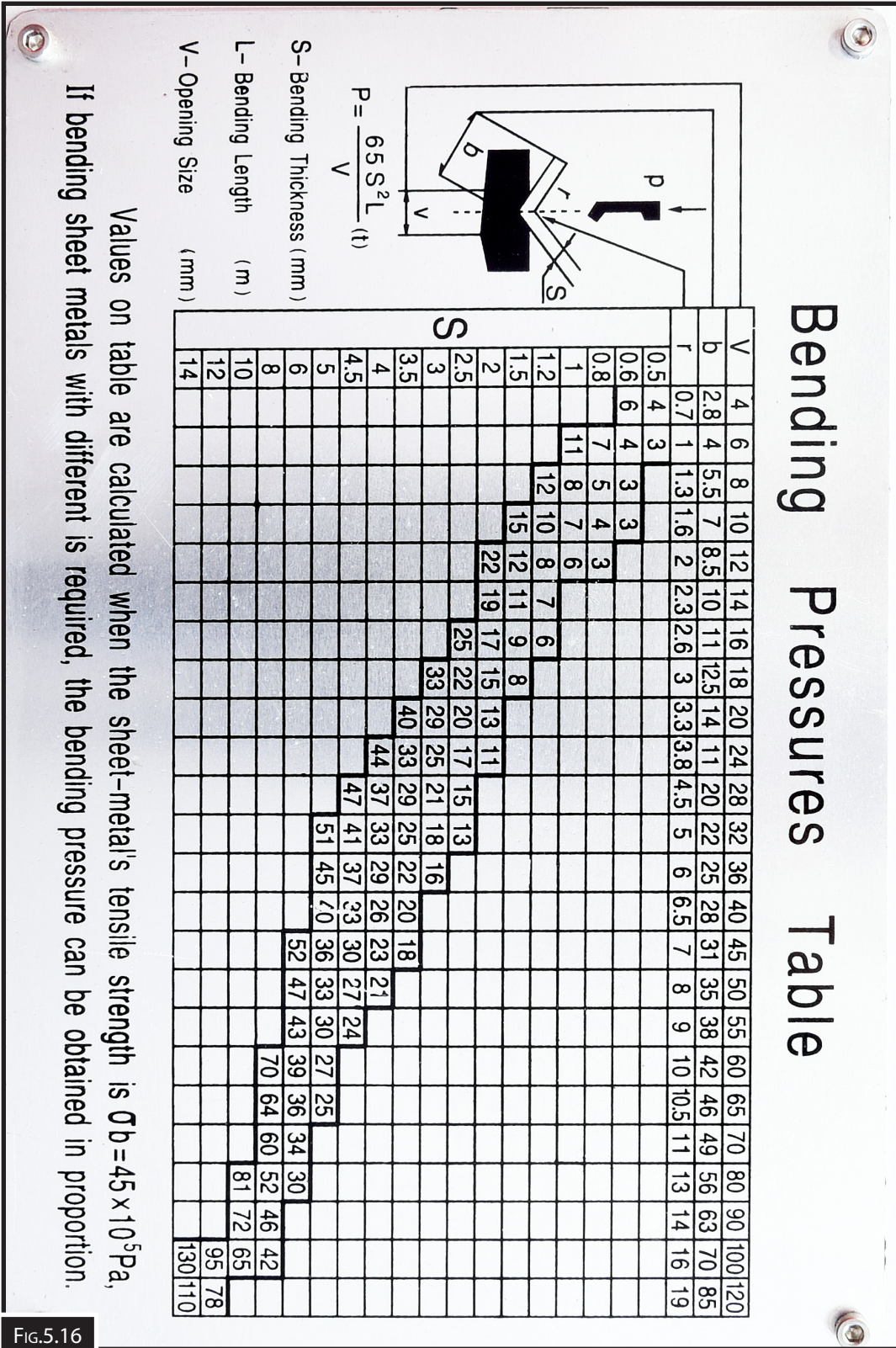

Fig.5.16

5.10 ADJUSTING THE TONNAGE

The pressure adjusting regulator is used to adjust the pressure applied between the punches and dies. To decrease the pressure, turn the knob counterclockwise (-) and to increase the pressure turn the knob clockwise (+) .

The maximum pressure capacity of this machine, is 21MPA
The Pressure gauge indicates the pressure applied between the punches and dies.



FIG.5.17

6. MAINTENANCE

6.1 MAINTAINING HYDRAULIC SYSTEM

When dirt, dust, and other foreign matter are deposited in large amounts in the hydraulic circuit, the hydraulic pump may produce abnormal noise and decrease in discharge capacity, and the ram may decrease in bending speed and vibrate. These conditions are attributable to the plugging of the filter in the hydraulic oil tank. Remove the filters, and change them and if the hydraulic oil is badly contaminated, then change it.

CHANGING HYDRAULIC OIL

Change the hydraulic oil after about first three months of machine operation and every year or 2000 hours of machine operation thereafter. (The hydraulic oil should be changed entirely even if it was added in the midway.)

NOTE: *When the hydraulic oil is changed, also change the filter in the hydraulic oil tank.*

To change the hydraulic oil:

- 1 Open the ram to the maximum opening limit.
- 2 Press the pump, OFF button and wait until the hydraulic pump motor stops.
- 3 Turn the master POWER ON/OFF switch to "OFF".
- 4 Remove all bolts fixing the top cover of the tank, and remove the top cover. (Fig.6.1)
- 5 Drain the old hydraulic oil from the tank into an empty can, using a pump. If the pump is not available, prepare an empty can with a capacity as to match the tank capacity, and place it below the drain plug of the tank. Remove the drain plug to drain the old hydraulic oil from the tank into the can.
- 6 Wipe the inside of the tank with a clean cloth.
- 7 Remove the filter from the tank and replace it with a new filter
8. Replace the drain plug if removed.
10. Pour new hydraulic oil into the tank until it reaches the middle of the sight gauge.(Fig.6.2)
11. Replace the tank top cover and wipe off any excess oil

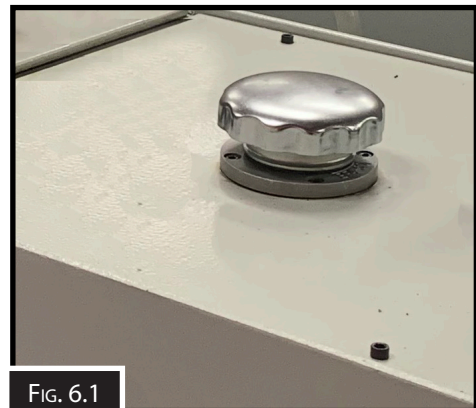

FIG. 6.1



FIG. 6.2

HYDRAULIC SYSTEM OF THE MACHINE

The hydraulic system working principles are displayed in Fig.1.

INACTIVE: When the oil pump is running, the oil feeds out, through an oil pipe and into the valve plate and solenoid valve, then returns into the oil tank. At this time the solenoid valve isn't working, The No.12 valve is closed and the top beam is stationary .

DOWN FAST: When the down button is pressed, valves YV1, YV2, YV4 operate. The pressurized oil enters into the top of the cylinders through valve No.10, and at the same time, because of the throttle valve effect, the pressure of the oil rises. This makes valve No12, and No. 15 open under pressure,. The beam moves down fast. The pressurized oil in the lower cavity of cylinder returns the oil to the oil tank through valves No.12, No.7 and N0.10. The cylinders top cavity forms a vacuum and fills the oil by valve No.15,

DOWN SLOW When the down switch is pressed, the SQ6,solenoid valve and YA1,YA4,YA5 are activated and the single valve No.15 is closed. A small aperture inside the system restricts the oil flow. The top beam enters work-speed,

UP FAST: When the up button is pressed the beam rises. The solenoid valve YV1 powers off Then YV1, YV3 valves power on, and with the effect of the throttle valve, the pressurized oil enters into the cylinder's lower cavity from valve No.10 and No.12. The beam returns, and the pressurized oil in cylinder's top cavity returns to oil tank by valve No.15. The foots-switch controls the top beam movement for inching work. The valve No.5 and No.16 adjust the working pressure of system. The overflow valve No.13 adjusts the return pressure. The pressure should be controlled within 12Mpa.

VALVE LOGIC TABLE

	YV1	YV2	YV3	YV4	YV5
INACTIVE	-	-	-	-	-
DOWNWARD FAST	+	+	-	+	-
DOWNWARD SLOW	+	-	-	+	+
PRESSURE	+	-	-	+	+
UPWARD	+	-	+	-	-
DECOMPRESSED	-	-	-	+	+

HYDRAULIC DIAGRAM

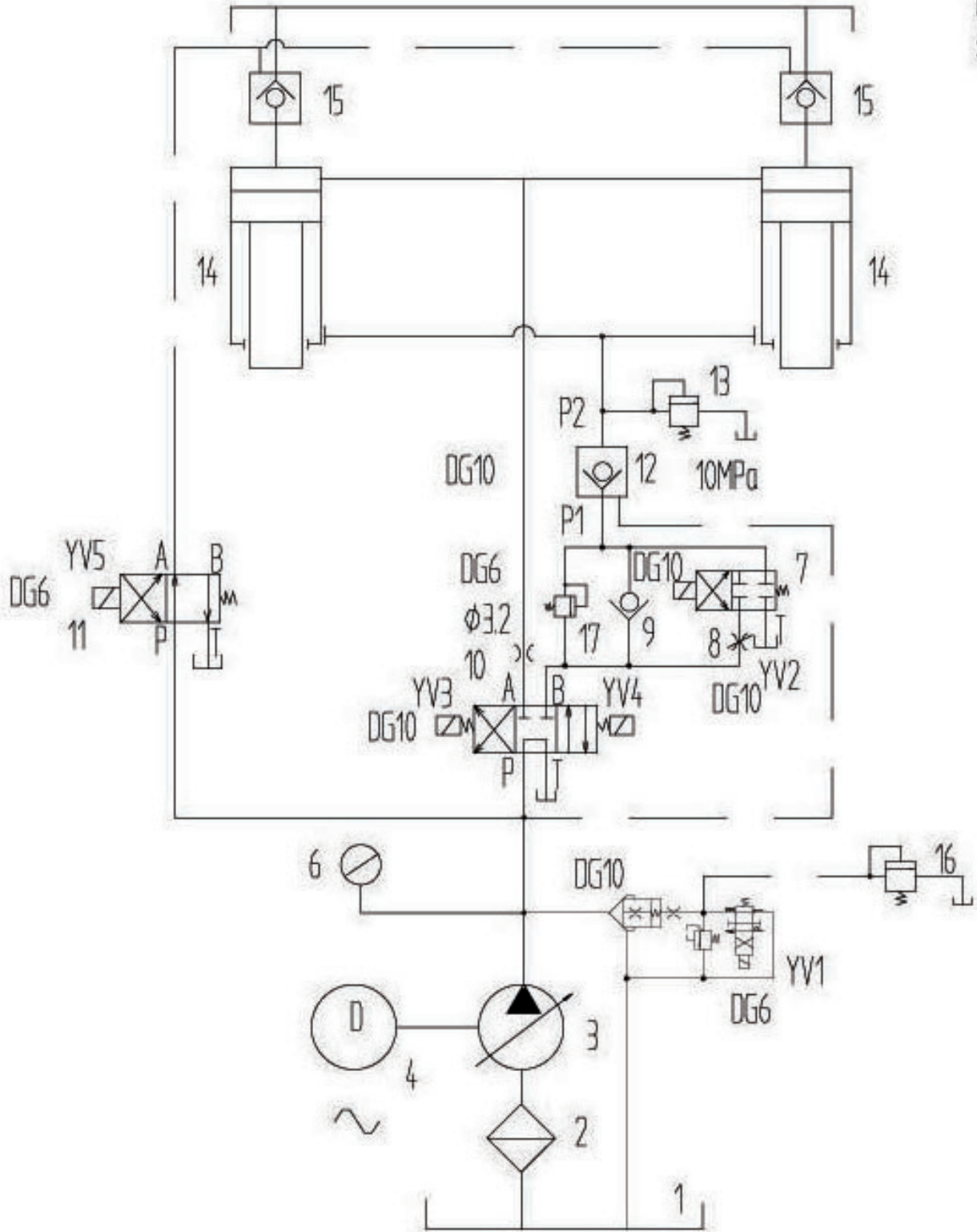

HYDRAULIC PARTS LIST

No.	Name	Type	Specification	Qty.	Remarks
1	Oil Tank			1	
2	Mesh Filter			1	
3	Gear Pump			1	
4	Motor			1	
5	Solenoid Overflow Valve			1	
6	Manometer			1	
7	Solenoid Reverse Valve			1	
8	Throttle Valve			1	
9	Valve			1	
10	Solenoid Reverse Valve			1	
11	Solenoid Reverse Valve			1	
12	Hydraulic Control Check Valve			1	
13	Distance Compressor Valve			1	
14	Oil Cylinder			2	
15	Hydraulic Control Check Valve			2	
16	Distance Compressor Valve			1	
17	Translation Overflow Valve			1	

6.2 LUBRICATION

! WARNING

Before maintaining or cleaning the machine, turn off the circuit breaker, and relieve the residual hydraulic pressure in the machine. Post a sign to inform other workers that the machine is under maintenance

Lubrication is very important to maintain bending accuracy and avoid machine troubles. Be sure to appropriately lubricate the machine according to the Lubrication chart below and s also found on the side of the machine.

DIAGRAM FOR LUBRICATING POINTS

No.	Name for lubricating points	Qty. of points	Periods	Kind of oil and brand
1	Counter for back gauge	2	48 hours	mechanical oil 46#
2	Sliding house	4	48 hours	lubricating greaseZG-3
3	Guideway	2	4 hours	lubricating greaseZG-3
4	Ram support	2	4 hours	lubricating greaseZG-3
5	Connecting rod bearing	2	8 hours	lubricating greaseZG-3
6	Connecting rod	2	4 hours	lubricating greaseZG-3
7	Gearbox	1	500 hours	lubricating greaseZG-3
8	Counter for upper trimming	2	48 hours	mechanical oil 46#

NOTE: When lubricating these points, 50% 46# mechanical oil should be added into.

6.3 TROUBLESHOOTING

Problem	Cause	Solution
Hydraulic Press Brake Pump drive is not working	Power switched off	Turn disconnect switch ON.
	The emergency STOP push button is pushed in.	Turn Emergency STOP push-button clockwise to release, then push START button.
	Control circuit fuse is blown.	Check for a possible cause. Remedy cause and replace the fuse
	Loose wire connections in control circuit wiring.	Check for electrical control wiring continuity using a multimeter. Repair as required.
Hydraulic Press ram cycle down in slow speed only.	Speed change position is not set correctly	Set the Mute Point correctly. Usually 14mm gap.
	High volume valve DOWN solenoid is defective	Check the solenoid. Repair or replace.
	Light curtain has been interrupted.	Remove obstruction interrupting the light curtain
Hydraulic pump is noisy	The hydraulic fluid level is low.	Check fluid level when press ram is in the up position. If required, add fluid until visible half way up the sight gauge.
	Pump inlet suction filter is blocked or obstructed.	Check the fluid condition. Replace hydraulic filter, fluid, and hydraulic filter as required.
	Hydraulic inlet piping or connections are loose" causing the pump to ingest air.	Check piping connections, O-ring at the pump to Inlet flange, and tighten inlet' flange bolts.
	Hydraulic pump shaft seal is defective, causing the pump to ingest air.	Check shaft seal for wear or damage. Replace if required.
Press ram does not return to the up-limit	Control mode is set to INCH	Switch to CYCLE mode, then activate the foot switch
	The ram up-limit switch is stuck or damaged in the activated position.	Check the limit switch mechanical function. Repair or replace.
	Loose connection or broken wire	Check for electrical continuity through to the up solenoids. Repair or replace.

6.3 TROUBLESHOOTING

Problem	Cause	Solution
Under bending in the middle of the formed part.	Tooling is worn in the center due to continuous forming of small parts in one location.	Re machine forming surfaces of tooling. Shim the die to compensate for worn areas.
	Press bed and top tool beam are worn in the center due to continuous forming of small parts in one location.	Re machine forming surfaces of press bed and top tool beam. Shim the die to compensate for worn areas.
Inconsistency from part to part	Press Top tool beam is free falling.	Check press top tool beam ways assembly adjustment.
	High-pressure directional control valve is defective or worn.	Inspect for damage or worn parts. Repair or replace.
Unequal angle at each end of the formed part	Variance in metal thickness.	Check material thickness at both ends of the part. Shim the die to compensate for material thickness variance.
	Variance in tooling height build-up at each end.	Shim the die to compensate for tooling height variances
Formed parts exhibit an inconsistent angle from end to end	Tension bar loose	Contact your service engineer.
	Worn ram cylinders	Contact your service engineer.
	Loose connecting bolts to the top tool beam	Contact your service engineer.

6.4 TOP TOOL HOLDER WEDGE ADJUSTMENT

Each top tool holder is fitted with an adjustment wedge, however Metalmaster advise that wedges were set at the factory and do not recommend that the wedges be adjusted. (Fig.6.3)

Metalmaster advise that shimming the bottom die is quicker and will save the operator time.

NOTE: *If at any time the wedges need to be adjusted we recommend that this be carried out by a Metalmaster service engineer*

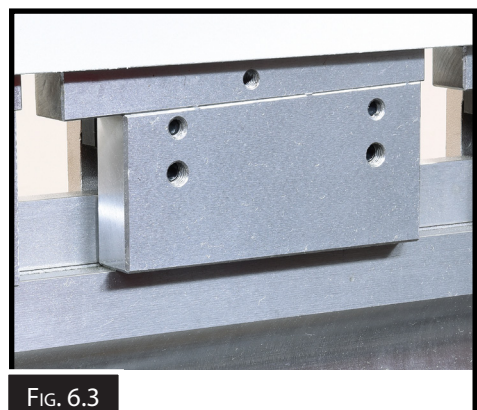

6.5 ONE PIECE 4 SIDED DIE

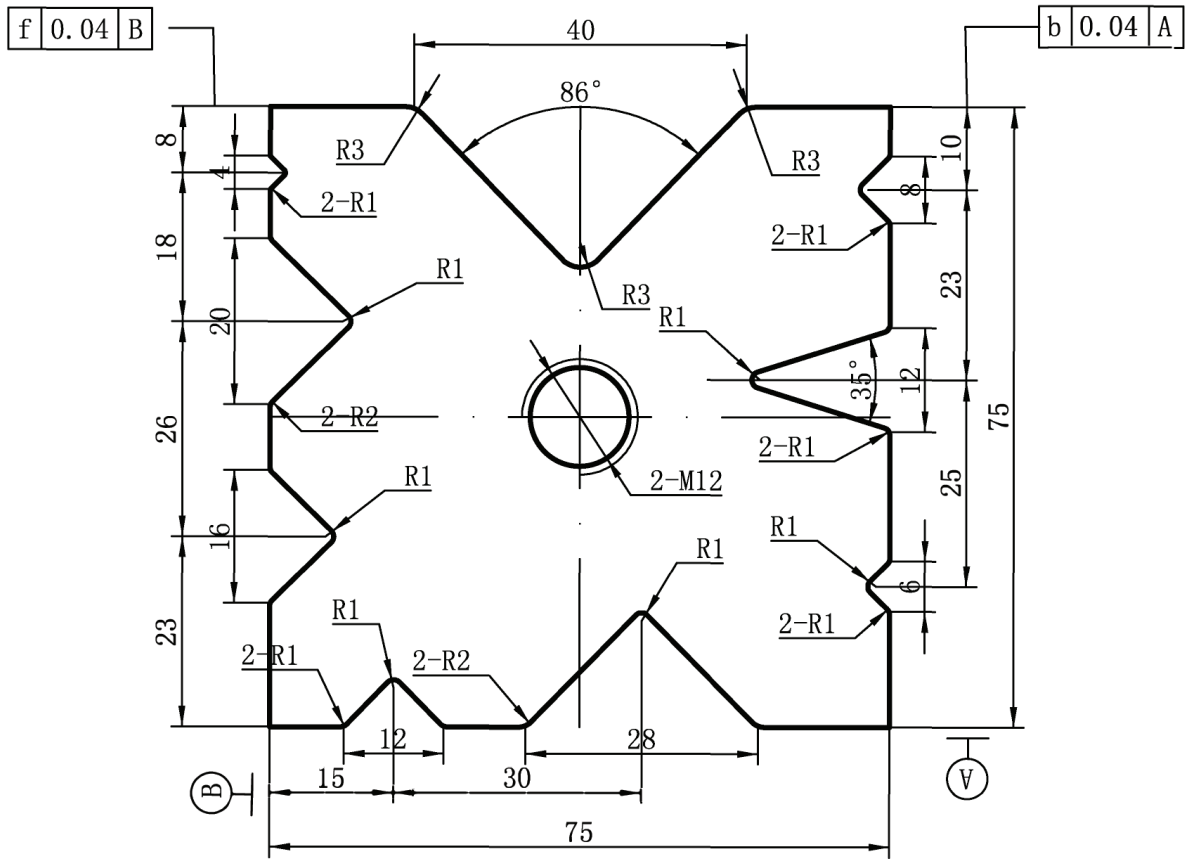

ALL ANGLES NOT MARKED ARE 86 DEGREE

6.6 SEGMENTED TOP PUNCH

TOP PUNCH - PB70E 2500MM (S900)

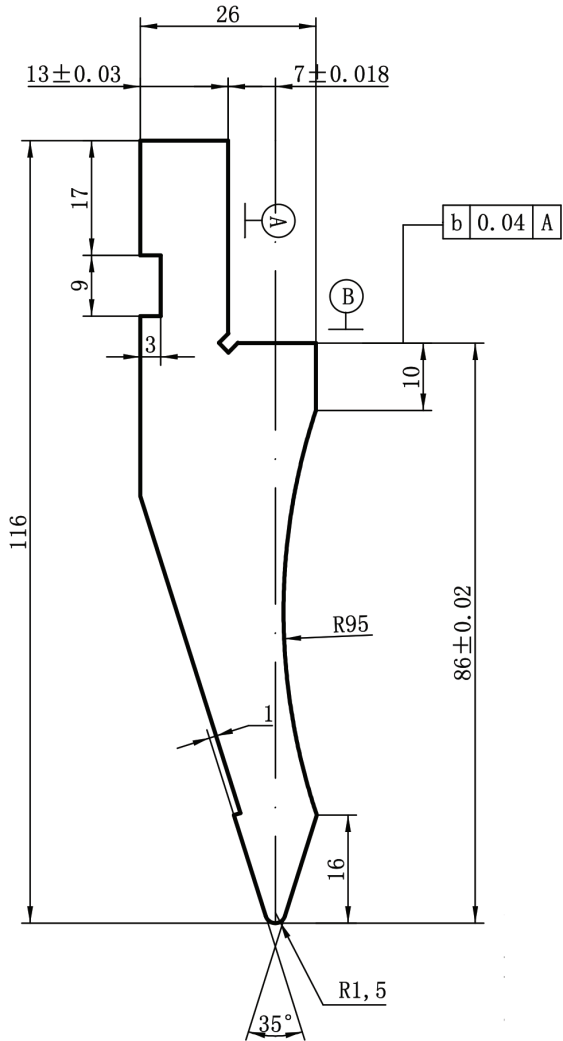

TOP PUNCH - PB70E 3200MM (S901)

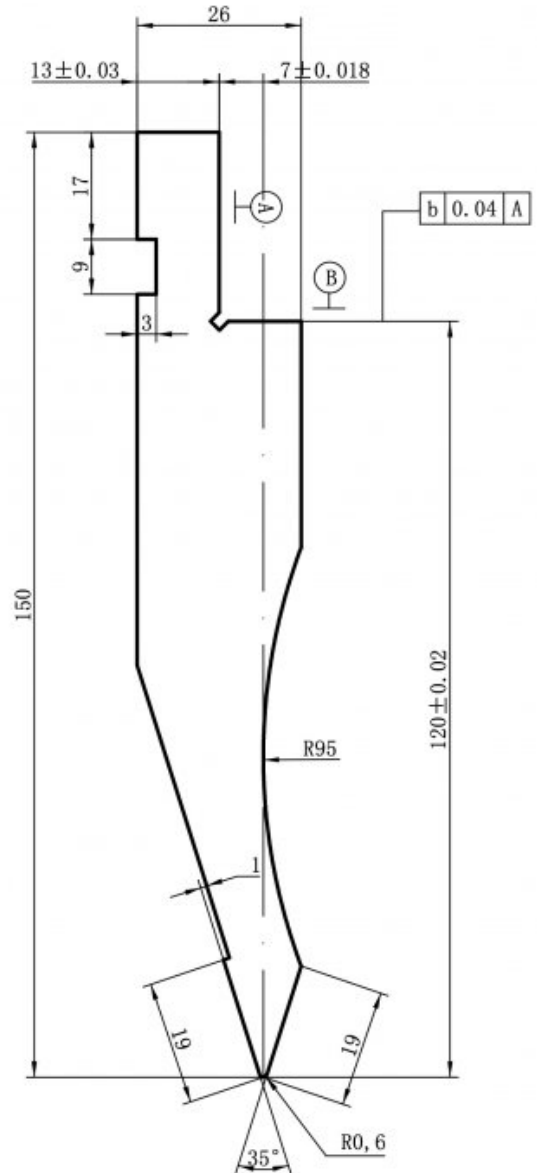

PB-70E WIRING DIAGRAM 1

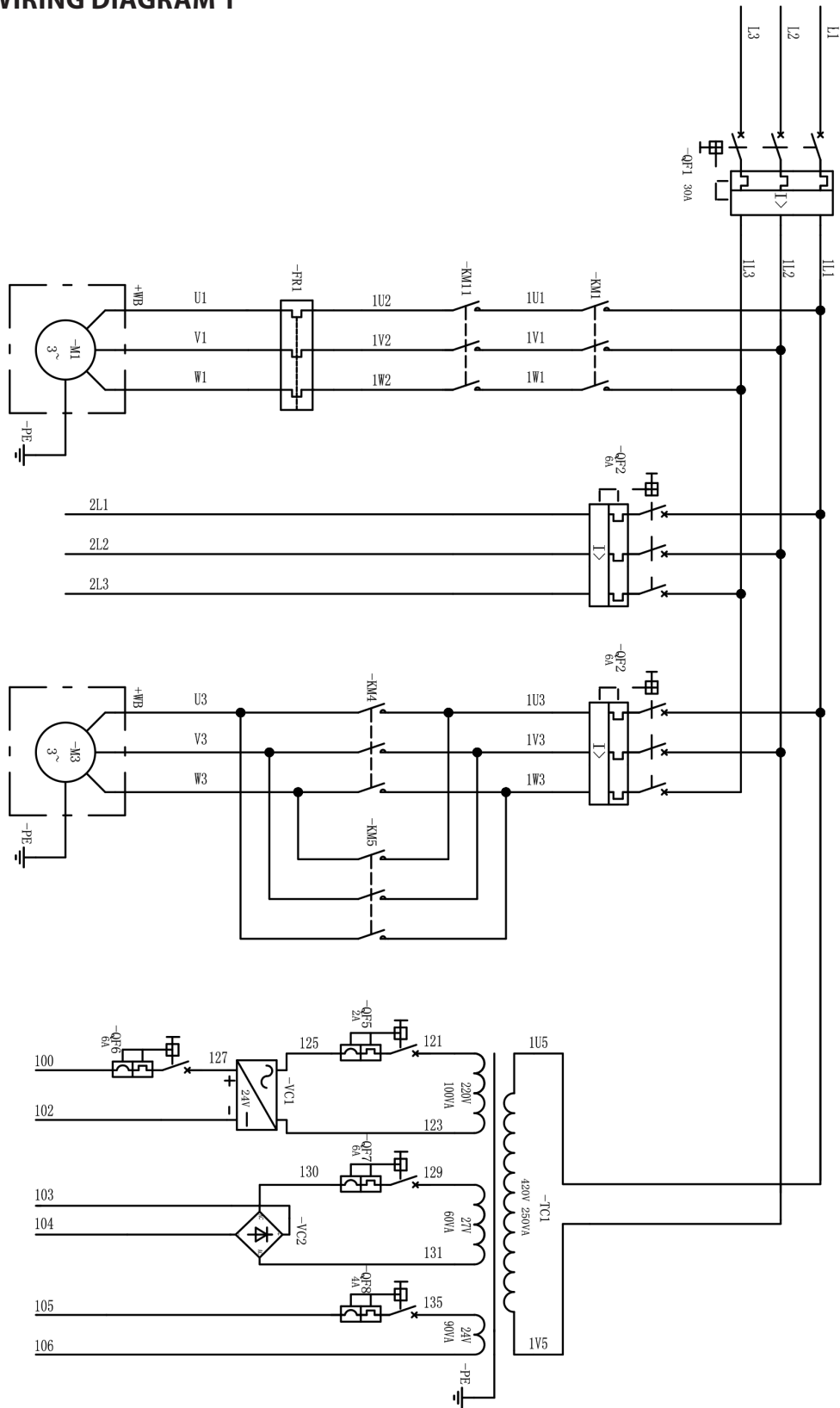

PB-70E WIRING DIAGRAM 2

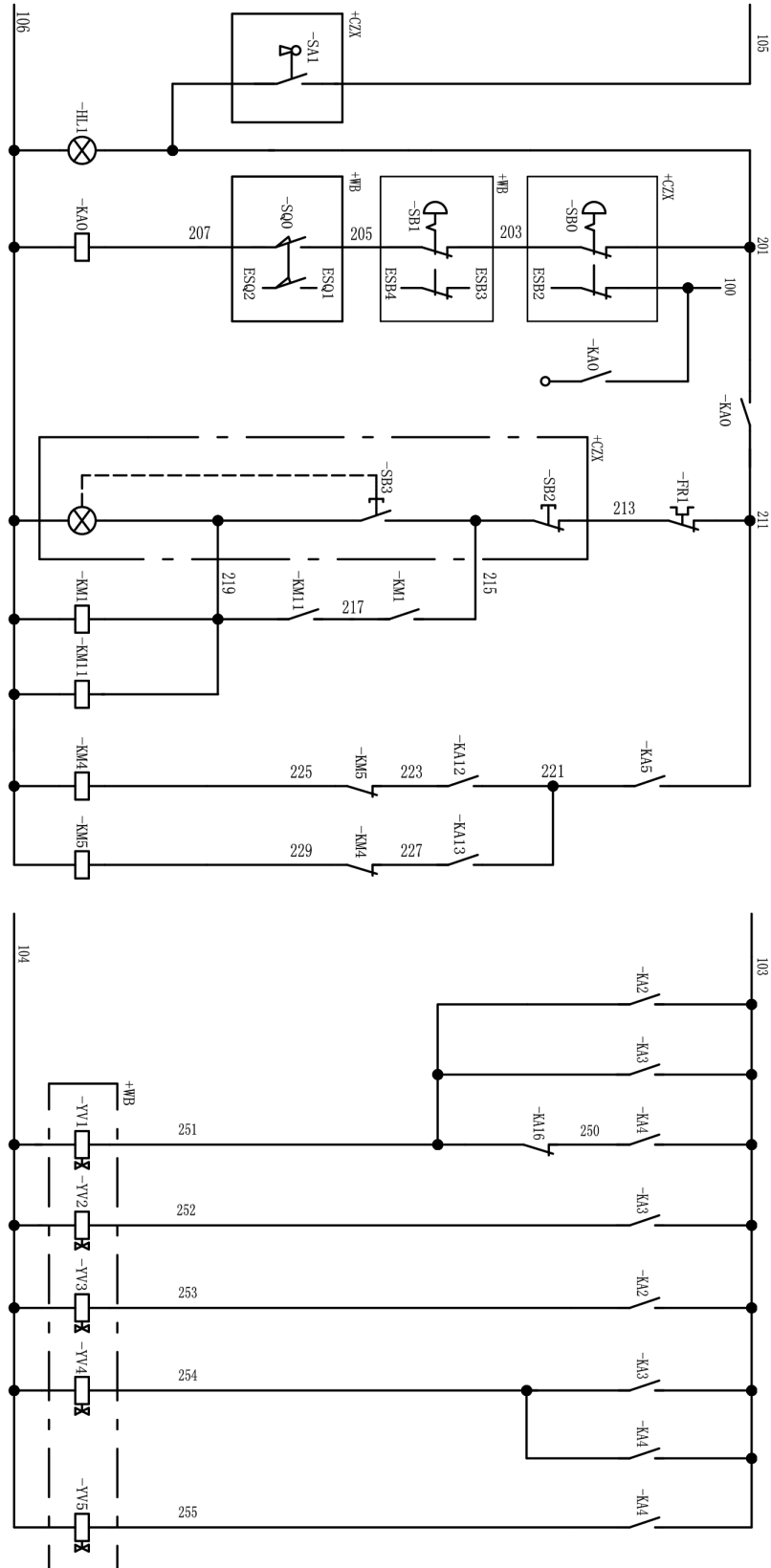

PB-70E WIRING DIAGRAM 4

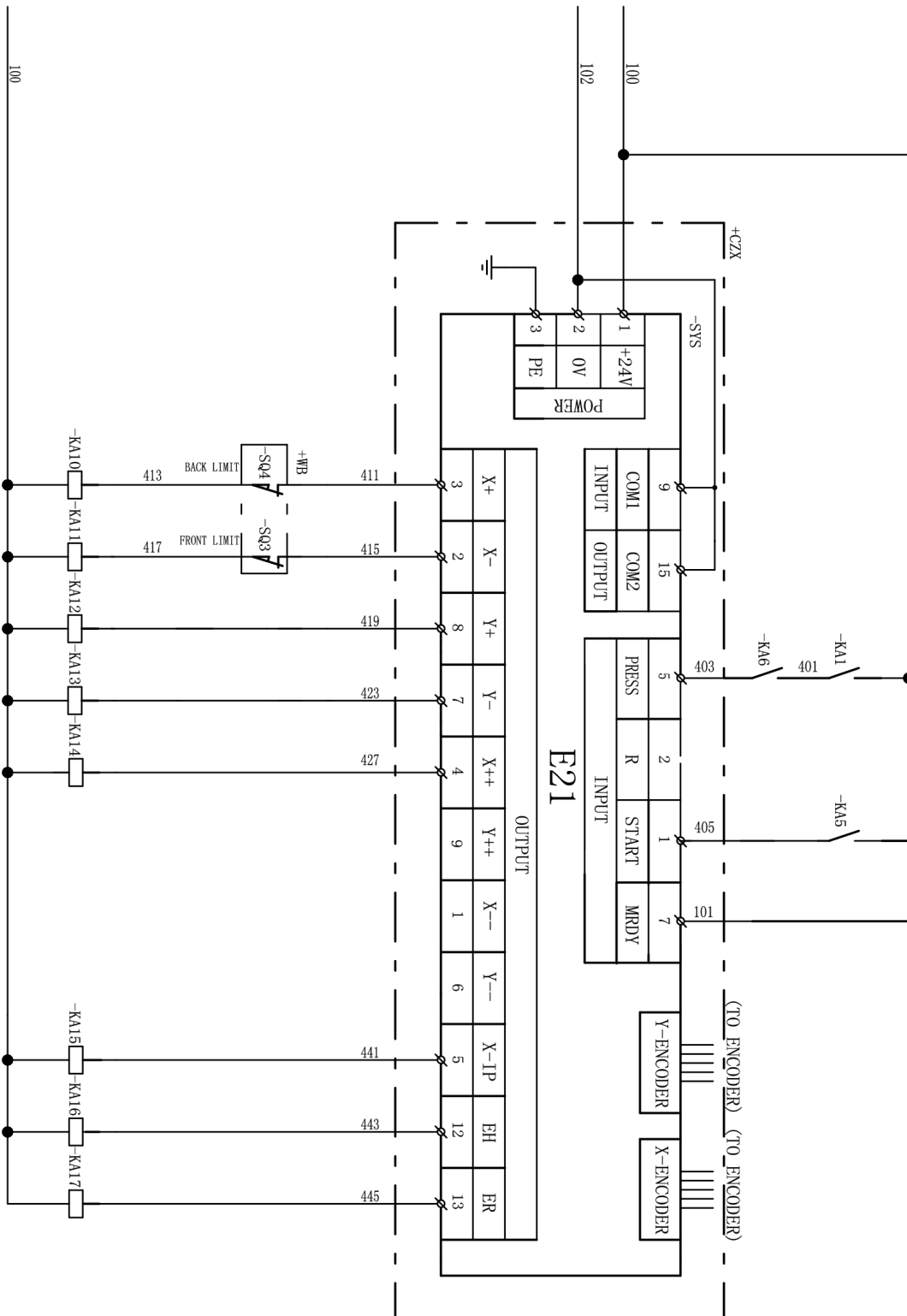

PB-70E WIRING DIAGRAM 5

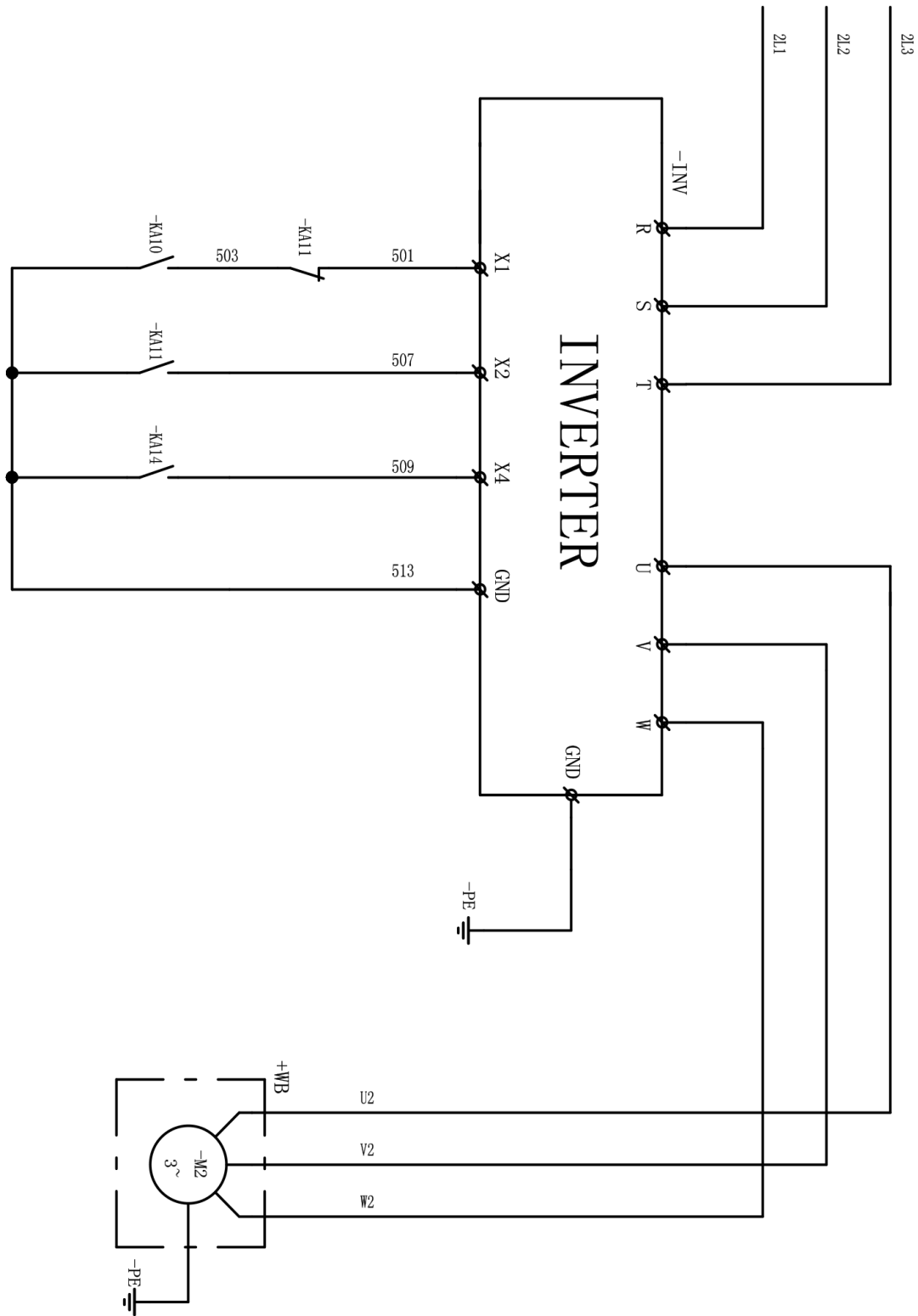

WARNING

General Machinery Safety Instructions

Machinery House
requires you to read this entire Manual before using this machine.

1. Read the entire Manual before starting machinery. Machinery may cause serious injury if not correctly used.
2. Always use correct hearing protection when operating machinery. Machinery noise may cause permanent hearing damage.
3. Machinery must never be used when tired, or under the influence of drugs or alcohol. When running machinery you must be alert at all times.
4. Wear correct Clothing. At all times remove all loose clothing, necklaces, rings, jewelry, etc. Long hair must be contained in a hair net. Non-slip protective footwear must be worn.
5. Always wear correct respirators around fumes or dust when operating machinery. Machinery fumes & dust can cause serious respiratory illness. Dust extractors must be used where applicable.
6. Always wear correct safety glasses. When machining you must use the correct eye protection to prevent injuring your eyes.
7. Keep work clean and make sure you have good lighting. Cluttered and dark shadows may cause accidents.
8. Personnel must be properly trained or well supervised when operating machinery. Make sure you have clear and safe understanding of the machine you are operating.
9. Keep children and visitors away. Make sure children and visitors are at a safe distance for your work area.
10. Keep your workshop childproof. Use padlocks, Turn off master power switches and remove start switch keys.
11. Never leave machine unattended. Turn power off and wait till machine has come to a complete stop before leaving the machine unattended.
12. Make a safe working environment. Do not use machine in a damp, wet area, or where flammable or noxious fumes may exist.
13. Disconnect main power before service machine. Make sure power switch is in the off position before re-connecting.
14. Use correct amperage extension cords. Undersized extension cords overheat and lose power. Replace extension cords if they become damaged.
15. Keep machine well maintained. Keep blades sharp and clean for best and safest performance. Follow instructions when lubricating and changing accessories.
16. Keep machine well guarded. Make sure guards on machine are in place and are all working correctly.
17. Do not overreach. Keep proper footing and balance at all times.
18. Secure workpiece. Use clamps or a vice to hold the workpiece where practical. Keeping the workpiece secure will free up your hand to operate the machine and will protect hand from injury.
19. Check machine over before operating. Check machine for damaged parts, loose bolts, Keys and wrenches left on machine and any other conditions that may effect the machines operation. Repair and replace damaged parts.
20. Use recommended accessories. Refer to instruction manual or ask correct service officer when using accessories. The use of improper accessories may cause the risk of injury.
21. Do not force machinery. Work at the speed and capacity at which the machine or accessory was designed.
22. Use correct lifting practice. Always use the correct lifting methods when using machinery. Incorrect lifting methods can cause serious injury.
23. Lock mobile bases. Make sure any mobile bases are locked before using machine.
24. Allergic reactions. Certain metal shavings and cutting fluids may cause an allergic reaction in people and animals, especially when cutting as the fumes can be inhaled. Make sure you know what type of metal and cutting fluid you will be exposed to and how to avoid contamination.
25. Call for help. If at any time you experience difficulties, stop the machine and call you nearest branch service department for help.

WARNING

Hydraulic Pressbrake Safety Instructions

Machinery House
requires you to read this entire Manual before using this machine.

- 1. Maintenance.** Make sure the Pressbrake is turned off and disconnect from the main power supply and make sure all moving parts have come to a complete stop before any inspection, adjustment or maintenance is carried out. Ensure the beam retaining bolts on the bottom of piston rams are checked to be tight on a regular maintenance schedule.
- 2. Pressbrake Condition.** Pressbrake must be maintained for a proper working condition. Never operate a Pressbrake that has low oil levels, damaged or worn parts. Scheduled routine maintenance should be performed on a scheduled basis.
- 3. Tooling Condition.** Never operate a Pressbrake with damaged or badly worn tooling. Replace if required.
- 4. Pump Direction.** Pump rotation must be in arrow direction otherwise the pump will be damaged.
- 5. Hand Hazard.** Do not insert or extend your hands in between bending tools, under any circumstances, while the machine is in operation mode. Serious injury can occur.
- 6. Gloves & Glasses.** Always wear leather gloves and approved safety glasses when using this machine.
- 7. Authorized and trained personnel.** The machine must be operated by authorized and trained personnel. The machine is designed to be operated by a single user. Using the machine with more than one operator is forbidden, except for certain maintenance situations.
- 8. Power outage.** In the event of a power failure during use of the machine, turn off all switches to avoid possible sudden start up once power is restored.
- 9. Work area hazards.** Keep the area around the Pressbrake clean from oil, tools, objects & chips. Pay attention to other persons in the area and know what is going on around the area to ensure unintended accidents. Do not access the rear of machine, while the machine is working
- 10. Guards.** Operate machine only with all protective devices and guarding in place and operational. Never remove, defeat or bypass. Any presence-sensing safeguarding used must have regular Safety integrity tests and records kept. These records must be kept for 5 years or for the life of the plant and be handed to any person that you relinquish control of the plant to. Tests include stop time measurements, safety distance calculations and inspections, with operator checks and periodic maintenance checks. (WHS Regulation 226)
- 11. Overloading Pressbrake.** Do not exceed the rated capacity of the pressbrake. Refer to the manual for correct capacity and bending chart.
- 12. Warning Labels.** Take note of any warning labels on the machine and do not remove them.
- 13. Protective fence.** Do not bridge the safety limit switch of the side and rear protective fences.
- 14. Support arms.** Do not use support arms for intermediate storage of workpieces.
- 15. Operation.** During the bending process, the workpiece may leap up. Therefore, the material must be handled carefully.
- 16. Emergency stop.** Use the emergency stop button in case of any emergency.
- 17. Level machine.** Level the machine on a flat concrete surface by using a spirit level.
- 18. Floor load for Installation.** The permissible floor load, where the machine is to be installed, must be accounted for.
- 19. Hearing protection and hazards.** Always wear hearing protection as noise generated from machine and workpiece can cause permanent hearing loss over time.
- 20. Heating Material.** Heating metal with a torch while the metal is in the bending brake will weaken the fingers.
- 21. Pinching.** Prevent pinching by lowering the bending brake fingers when not in use.
- 22. Call for help.** If at any time you experience difficulties, stop the machine and call your nearest branch service department for help.

PLANT SAFETY PROGRAM
NEW MACHINERY HAZARD IDENTIFICATION, ASSESSMENT & CONTROL

Hydraulic Pressbrake

Developed in Co-operation Between A.W.I.S.A and Australia Chamber of Manufactures
 This program is based upon the Safe Work Australia, Code of Practice - Managing Risks of Plant in the Workplace (WHSA 2011 No10)

Item No.	Hazard Identification	Hazard Assessment	Risk Control Strategies <small>(Recommended for Purchase / Buyer / User)</small>
B	CRUSHING	LOW	Secure & support work material on table. Care must be taken when removing blades. Regular maintenance Schedule must be maintained
C	CUTTING, STABBING, PUNCTURING	MEDIUM	Wear gloves to prevent cuts from sharp material offcuts.
DS	HEARING	MEDIUM	Hands should be kept clear of moving parts. Isolate power to machine prior to any checks or maintenance. Do not adjust or clean until machine has fully stopped. Machine must be fitted with guarding, (see workcover authority principles to machine guarding for guidelines).
F	STRIKING	MEDIUM	Ensure guards are secured properly. Wear safety glasses. Stand clear of falling offcuts. Keep clear of bending material.
H	ELECTRICAL	MEDIUM	Machine should be installed & checked by a Licensed Electrician. All electrical enclosures should only be opened with a tool that is not to be kept with the machine.
O	OTHER HAZARDS, NOISE.L	OW	Wear hearing protection as required.

Plant Safety Program to be read in conjunction with manufactures instructions



www.machineryhouse.com.au



www.machineryhouse.co.nz

Authorised and signed by:
 Safety officer:
 Manager: 

Revised Date: 25th Sept 2015